

# EDGESolo275 Woodworks®



Direct | Standard Lengths

Project Name \_\_\_\_\_

Fixture Type \_\_\_\_\_

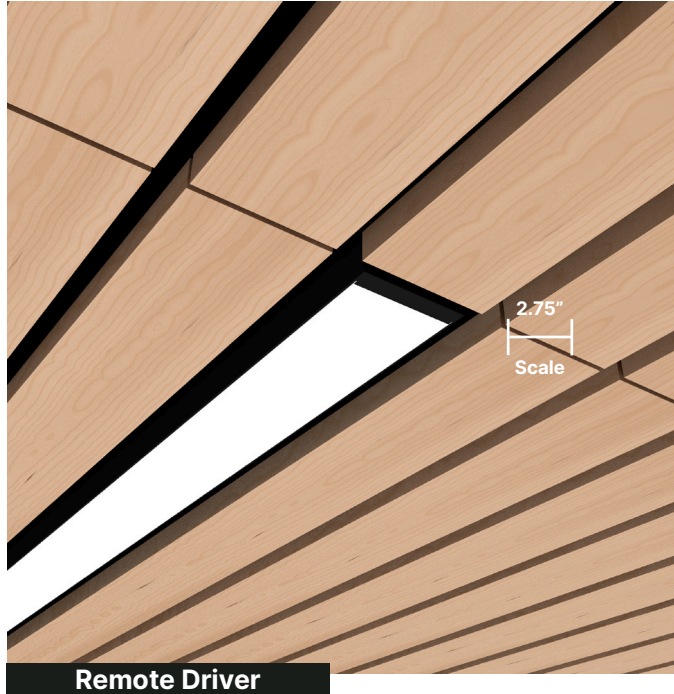

## DESCRIPTION

### 2.75" x 1.0" Edge-Lit Linear for Wood Ceiling Grids

EDGESolo275 Woodworks is an innovative low-profile LED luminaire designed to fit within a 2.75" space between grills in an Armstrong Woodworks Ceiling panel. EDGESolo275 Woodworks is only 1" high and provides the perfect direct light with a range of symmetric and asymmetric lighting distributions available. EDGE products all provides best-in-class efficiency and beam control options. EDGESolo275 Woodworks is specification-grade with high lumen per foot, high CRI, and circadian options. EDGESolo275 Woodworks incorporates an engineered LED light engine with fully customizable choices for lumen output, CCT, and CRI.

## FEATURES & BENEFITS

### Exceptional Performance

Up to 1,000 lm/ft, 135 lm/W efficacy. Low Glare (UGR<19) WELL Building Standard™ and LEED certified when specified less than 400 lm/ft.

### LED Selections

Static

### Designed with Options

Wide choice of SmartOptic® lenses, beam distributions, 80/90/95+ CRI, 2700K to 6500K CCT, and 0-10V, DALI, DMX, and TRIAC dimming

### Patented Innovations

Fusion® Optix Inside with unique SmartBeam® capabilities

### Proprietary Optical Components

Provides excellent light distribution and high-transmission

### Committed to Sustainability

Declare Listed and Red Free List materials

### Compliance

UL Listed, Dry and Damp Locations

### 5-Year Warranty

Standard 5-year warranty, 50,000 hours

## LIGHTING CONFIGURATIONS

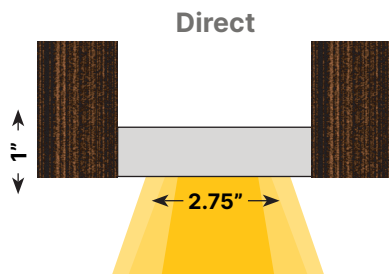

## FIXTURE ORDERING

Project Name \_\_\_\_\_

Fixture Type \_\_\_\_\_

### 1) FIXTURE DESIGN

PRODUCT	FIXTURE LENGTH	FINISH	END CAP STYLE
<b>ESO275-WW</b> 2.75" Aperature Linear Downlight for Wood Ceiling Grids	<b>2</b> - 2 ft <b>4</b> - 4 ft <b>6</b> - 6 ft <b>8</b> - 8 ft <b>X_</b> - Specify Ft', In"	<b>Powder Coated</b> <b>PMW</b> - Matte White <b>PMB</b> - Matte Black <b>PMG</b> - Matte Gray <b>PRAL_</b> - Specify RAL #	<b>E1</b> - Flat End Cap <b>E2</b> - Chamfered End Cap
	Custom fixtures are available in 3" increments beyond standard lengths.	<b>Anodized</b> <b>ACL</b> - Clear Anodized <b>ACU_</b> - Custom Anodized #	

### 2) LED LIGHT ENGINE

CRI	CCT	OPTIC (DIRECT ONLY)	DIRECT BEAM PATTERN	DIRECT OUTPUT
<b>80</b> - Std. 80 CRI <b>90</b> - Std. 90 CRI <b>95</b> - High-Def. 95 CRI <b>SUN</b> - Full SunLike	<b>27</b> - 2700K <b>30</b> - 3000K <b>35</b> - 3500K <b>40</b> - 4000K <b>X_</b> - Specify CCT	<b>OSL</b> - Standard Lens <b>WLB</b> - White Linear Baffle <sup>1</sup> <b>BLB</b> - Black Linear Baffle <sup>1</sup> <b>WHB</b> - White Hexagonal Baffle <sup>1</sup> <b>BHB</b> - Black Hexagonal Baffle <sup>1</sup> <b>CHB</b> - Chrome Hexagonal Baffle <sup>1</sup>	<b>DLAM</b> - Lambertian <b>DBW65</b> - Batwing 65° <b>DA5025</b> - Asym 50° at 25° Tilt <b>X_</b> - Specify Beam <sup>2</sup>	<b>35</b> - 350 lm/ft <b>50</b> - 500 lm/ft <b>75</b> - 750 lm/ft <b>100</b> - 1,000 lm/ft <b>X_</b> - Specify lm/ft
		<b>GRL</b> - Glare Reduction Lens (LEED certified and meets the WELL Building Standard™ with output less than 400 lm/ft)	<b>DLAM</b> - Lambertian	

### 3) FIXTURE POWER & CONTROLS

LINE VOLTAGE (DC)	REMOTE DRIVER (POWER) <sup>3</sup>	
<b>UNV</b> - 120/277V <b>347</b> - 347V	<b>FDND</b> - Factory Non-Dimming <b>FD00</b> - Factory 0-10V 0.1% Dim <b>FD01</b> - Factory 0-10V 1% Dim <b>FD10</b> - Factory 0-10V 10% Dim <b>FDDA</b> - Factory DALI 0.1% Dim <b>FDDX</b> - Factory DMX Dim <b>FDTR</b> - Factory TRIAC Dim <b>LD01</b> - Lutron Hi-Lume 1% Dim <b>X_</b> - Specify Driver	Footnotes: <sup>1</sup> Baffle lens options reduce efficacy. Contact factory for lm/W data. <sup>2</sup> Contact factory about custom beam options. <sup>3</sup> Standard driver box is included

### 4) FIXTURE MOUNTING & CONNECTIONS

WOODWORKS TYPE	MOUNTING KIT	POWER CORD
<b>A1</b> - Grille Classic <b>A2</b> - Grille Tegular 9/16" <b>A3</b> - Grille Tegular 15/16" <b>A4</b> - Grille Forte <b>A5</b> - Linear Solid Wood Panels <b>A6</b> - Linear Veneered Panels <b>A7</b> - Turf Ceiling	<b>WW225</b> - XICO Integration Clip Slat Hgt 2.25" <b>WW325</b> - XICO Integration Clip Slat Hgt 3.25" <b>WW425</b> - XICO Integration Clip Slat Hgt 4.25" <b>WW40T</b> - XICO Integration Clip Turf UNV	<b>P24W</b> - 24" White Cable Kit <b>P24B</b> - 24" Black Cable Kit

<b>OPTIONAL</b>	
EMERGENCY BACKUP	WIRELESS MODULE
<p><b>EMC</b> - Emergency Circuit  <b>EMB</b> - Emergency Battery (10W — Remote)  <b>X_</b> - Specify Backup</p> <p>Specify requirements at time of order.</p>	<p><b>WCN</b> - Wireless Communication Node (Connected to LED Driver In-Fixture or In-Driver Box)  <b>PIR</b> - Wireless Communication Node + PIR Sensor (Standard Lens for Low Bay &lt; 10')  <b>MW</b> - Wireless Communication Node + MW Sensor (Standard for Low Bay &lt; 10')  <b>X_</b> - Other – Specify Embedded Component or Specific Non-Standard Sensor Detection Range</p>

## DIMENSIONS & INSTALLATION

### Dimensions

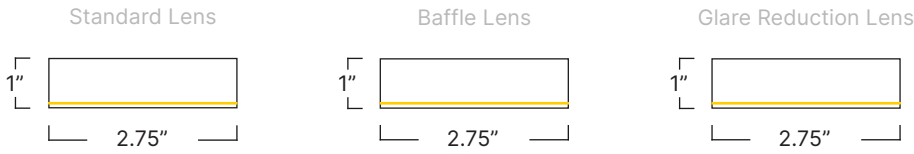

### Standard Fixtures

2ft	23.05" / 23.4"
4ft	47.05" / 47.4"
6ft	71.05" / 71.4"
8ft	95.05" / 95.4"

Lens Length / Fixture Length

### Mounting Type

#### Woodworks Integration

Installs into a wood slat cavity via an integration clip. Available with a range of accessories, mounts and inserts that provide easy customization of visual appearance and performance enhancements.

### Mounting Options

#### Mounting Method

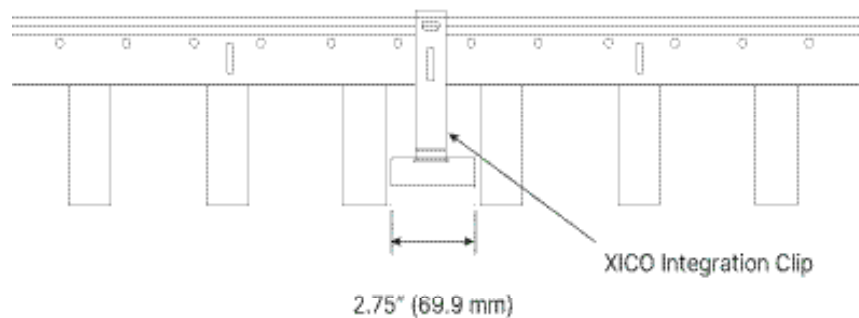

## SMARTBEAM® TECHNOLOGY

### The Ultimate Control of Lighting Distributions

SmartBeam makes it easy to specify the exact light required for any architectural space. Available in every XICO product; it is now possible to create truly tailored and engaging lighting that transform spaces, improves visual comfort, and saves energy.

To learn more about our SmartBeam Technology, please click or scan the QR Code.



### Direct Optics Choices

DIRECT OPTICS	BEAM PATTERN		
	DLAM	DBW65	DA5025
Standard Lens	■	■	■
Linear Baffle	■	■	■
Hexagonal Baffle	■	■	■
Glare Reduction Lens	■		

### LPW Efficacy Conversion Chart

CODE	CCT SELECTED							
	2200K	2700K	3000K	3500K	4000K	5000K	5700K	6500K
80	–	0.91	0.96	1.00	1.04	1.11	1.11	1.11
90	–	0.91	0.96	1.00	1.04	1.11	1.11	1.11
95	–	0.91	0.96	1.00	1.04	1.11	1.03	1.04
SUN	–	0.90	0.92	1.00	1.01	1.07	1.04	1.05

### LPW Performance

	DIRECT		
	DLAM	DBW65	DA5025
LM/W	110	109	141

## DIRECT PHOTOMETRICS

Static White Light

48" Length, 80+/3500K CRI/CCT, 3,000 Lumens

**DLAM:** Lambertian

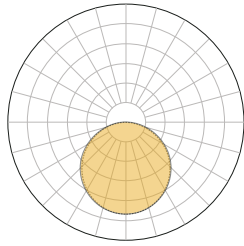

LM/FT	W/FT	LM/W
350	3.2	109.4
500	4.5	111.1
750	6.8	110
1000	9.1	109.9

**DBW65:** Batwing 65°

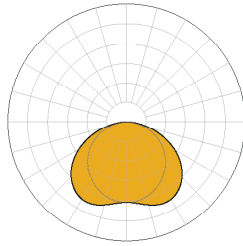

LM/FT	W/FT	LM/W
350	3.2	109.4
500	4.5	111.1
750	6.8	109
1000	9.1	109.9

**DA5025:** Asymmetric 50° at 25° Tilt

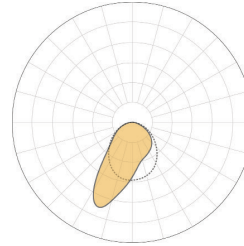

LM/FT	W/FT	LM/W
350	2.5	140
500	3.5	142.9
750	5.3	141
1000	7.1	140.8

COMPATIBLE OPTIC			
FLUSH LENS	LINEAR BAFFLE	HEXAGONAL BAFFLE	GLARE REDUCTION LENS
■	■	■	■

## OPTICS CONFIGURATIONS

Standard Lens	Linear Baffle	Hexagonal Baffle	Glare Reduction Lens
White Standard Lens <b>OSL</b>	White Linear Baffle <b>WLB</b>	White Hexagonal Baffle <b>WHB</b>	White Glare Reduction Lens <b>GRL</b>
	Black Linear Baffle <b>BLB</b>	Black Hexagonal Baffle <b>BHB</b>	
		Chrome Hexagonal Baffle <b>CHB</b>	

## WELL Building Standard™ and LEED Certification

EDGESolo products are LEED certified and meet the WELL Building Standard™ for low glare (UGR <19) when specified with a low-glare lens option and configured at or below maximum lumen-per-foot output. Refer to the chart below for qualifying configurations and performance data.

LM/FT	EDGESolo			
	ESO200	ESO275	ESO325	ESO525
350				
400				
500				
750				

LED OPTIONS

80: Standard 80+ CRI

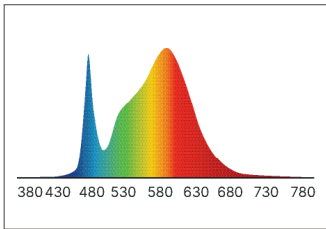

90: Standard 90+ CRI

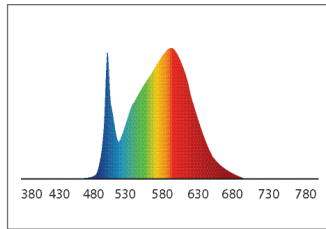

95: High-Definition 95+CRI

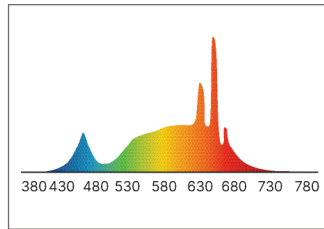

SUN: Full Spectrum "SunLike"

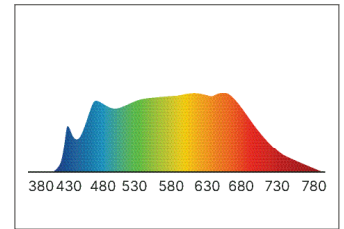

CODE	DESCRIPTION	TYPICAL LED DATA							
		CCT	CRI	CRI R9	TM30 Rf	TM30 Rg	CQS	M/P Ratio	LPW
80	Standard 80 CRI	3500K	82.5	7.8	84	96.7	82.5	0.51	190
90	Standard 90 CRI	3500K	91	54.3	89.3	98.9	89.2	0.55	175
95	High Definition 95 CRI	3500K	97.1	95	-	-	-	0.70	163
SUN	Full Spectrum SunLike®	3500K	95	85	-	-	-	-	130

## POWER & CONTROLS

### Voltage

#### Fixture Voltage (AC)

120–277 VAC  
347 VAC, 50/60 Hz

#### Power Location

Remote

#### LED Driver

Factory Selected, 36–39V Constant Current

### Drivers

**FDND** - Factory Non-Dimming  
**FD00** - Factory 0-10V 0.1% Dim  
**FD01** - Factory 0-10V 1% Dim  
**FD10** - Factory 0-10V 10% Dim  
**FDDA** - Factory DALI 0.1% Dim  
**FDDX** - Factory DMX Dim  
**FDTR** - Factory TRIAC Dim  
**LD01** - Lutron Hi-Lume 1% Dim  
**X\_** - Specify Driver

### Emergency Backup (Optional)

**EMC** - Emergency Circuit  
**EMB** - Emergency Battery  
 (10 W — Remote)  
**X\_** - Specify Backup

#### Power

10 W

#### Illumination Time

90 minutes

### IP Rating

Suitable for Dry and Damp Locations,  
indoor use only

### XBox

#### Remote Driver Boxes (Optional)

To create a clean and organized power solution for multiple fixture installations see our XBox Specification Guide. Reach out to a XICO Sales Representative to discuss your projects needs.

### Compatible Control Options



TECHNICAL SPECIFICATIONS

Finishes & Design Options

Powder Coated Housing Colors (Matte Finish)

- White (RAL9003)
- Black (RAL9005)
- Gray (RAL7001)
- Custom RAL



Housing Material

6063-T5 extruded, recycled aluminum

Mounting Brackets

Sheet Metal

End Cap Material

6063-T5 extruded, recycled aluminum

Lens Options and Material

Standard, Baffle and Glare Reduction lens options with Patented SmartOptics® made from Acrylic (PMMA)

Standards & Certifications

Sustainability

Low carbon, environmentally conscious packaging and shipping methods

Compliance

BABAA & TAA compliant in-house manufacturing in Boston, MA with North American supply chain



Certifications



Declare Listed and Red List Free

Low carbon, environmentally conscious packaging and shipping methods

Recyclable

SmartOptics and all powder coated and anodized parts are fully recyclable at end of life

Manufacturing

All XICO products and associated optics and LED engines are assembled at our factory in Woburn, MA

Quality Assurance

Each product is engineered for reliability and tested for quality assurance

Declare.

Nano Series  
XICO Lighting

Final Assembly: Woburn, MA, USA  
Life Span: 10+ Years  
End of Life Option: Recyclable (99%)

Ingredients:

Aluminum, Glass, oxides, chemicals, Polymethyl methacrylate, Phenol, 4,4'-[1,1'-methylenebis(4-oxo-2-phenylene)]diphenyl ether, 2,2'-(2,2,6,6-tetramethylpiperidine-1,1'-diyl)bis(4-phenyleneoxy)ethylene[2,2'-(2,2,6,6-tetramethylpiperidine-1,1'-diyl)bis(4-phenyleneoxy)ethylene], 1,3-diphenyl isocyanate, 1,4-dimethyl-1,4-bis(methacryloyloxy)butane and 1,2-ethanedithiol, Polyethylene Glycol, Polyethylene Terephthalate, Barium sulfate, Magnesium, Silicon, Phosphoric acid, di-nonyl ester zinc, Siloxane and Siloxane, di-Nitro Chromium, metallic Gold, Manganese Titanium, Zinc Nickel (metallic)

Declare Listed

At Xico Lighting, we are committed to transparency and sustainability. That's why all our products are Declare listed, providing clear insights into their environmental footprint and safety. Look for these internationally recognized labels on Xico products, packaging, or at [xicoled.com/declare](http://xicoled.com/declare).



Red List Free

Xico Lighting is dedicated to creating safe, sustainable solutions. All our products are Red List Free, meeting the highest industry standards for healthy and environmentally responsible materials as defined by the International Living Future Institute (ILFI). Learn more at [xicoled.com/declare](http://xicoled.com/declare).

Quick Links

5-YR Warranty

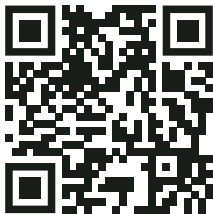

Business Terms



Patents & Trademarks



SmartBeam



Revit Files

