

EDGESolo525 Woodworks®



Direct | Standard Lengths

Project Name _____

Fixture Type _____

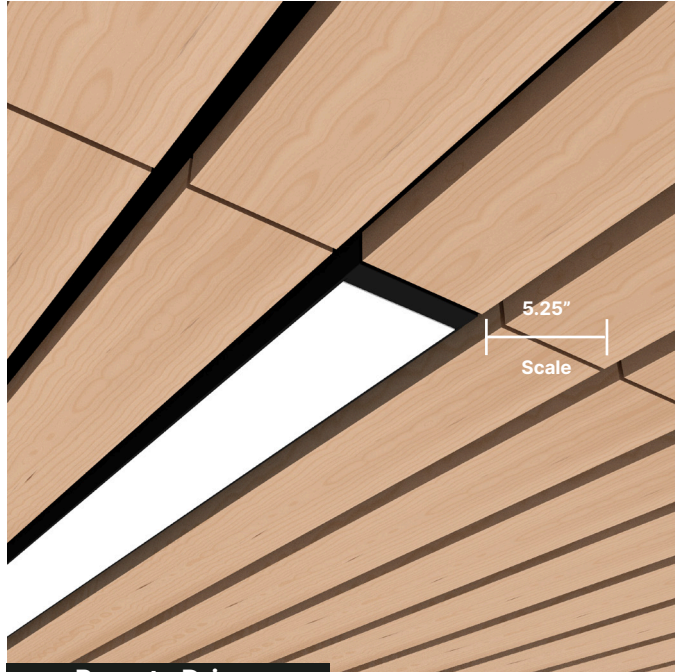

DESCRIPTION

5.25" x 1.0" Edge-Lit Linear for Wood Ceiling Grids

EDGESolo525 Woodworks is an innovative low-profile LED luminaire designed to fit within a 5.25" space between grills in an Armstrong Woodworks Ceiling panel. EDGESolo525 Woodworks is only 1" high and provides the perfect direct light with a range of symmetric and asymmetric lighting distributions available. EDGE products all provides best-in-class efficiency and beam control options. EDGESolo525 Woodworks is specification-grade with high lumen per foot, high CRI, and circadian options. EDGESolo525 Woodworks incorporates an engineered LED light engine with fully customizable choices for lumen output, CCT, and CRI.

FEATURES & BENEFITS

Exceptional Performance

Up to 1,000 lm/ft, 135 lm/W efficacy. Low Glare (UGR<19) WELL Building Standard™ and LEED certified when specified less than 750 lm/ft.

LED Selections

Static

Designed with Options

Wide choice of SmartOptic® lenses, beam distributions, 80/90/95+ CRI, 2700K to 6500K CCT, and 0-10V, DALI, DMX, and TRIAC dimming

Patented Innovations

Fusion® Optix Inside with unique SmartBeam® capabilities

Proprietary Optical Components

Provides excellent light distribution and high-transmission

Committed to Sustainability

Declare Listed and Red Free List materials

Compliance

UL Listed, Dry and Damp Locations

5-Year Warranty

Standard 5-year warranty, 50,000 hours

LIGHTING CONFIGURATIONS

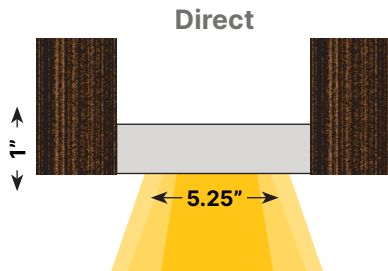

FIXTURE ORDERING

Project Name _____

Fixture Type _____

1) FIXTURE DESIGN

PRODUCT	FIXTURE LENGTH	FINISH	END CAP STYLE
ESO525-WW 5.25" Aperature Linear Downlight for Wood Ceiling Grids	2 - 2 ft 4 - 4 ft 6 - 6 ft 8 - 8 ft X_ - Specify Ft', In"	Powder Coated PMW - Matte White PMB - Matte Black PMG - Matte Gray PRAL_ - Specify RAL #	E1 - Flat End Cap E2 - Chamfered End Cap
	Custom fixtures are available in 3" increments beyond standard lengths.	Anodized ACL - Clear Anodized ACU_ - Custom Anodized #	

2) LED LIGHT ENGINE

CRI	CCT	OPTIC (DIRECT ONLY)	DIRECT BEAM PATTERN	DIRECT OUTPUT
80 - Std. 80 CRI 90 - Std. 90 CRI 95 - High-Def. 95 CRI SUN - Full SunLike	27 - 2700K 30 - 3000K 35 - 3500K 40 - 4000K X_ - Specify CCT	OSL - Standard Lens GRL - Glare Reduction Lens (LEED certified and meets the WELL Building Standard™ with output less than 750 lm/ft)	DLAM - Lambertian DBW65 - Batwing 65° DA5025 - Asym 50° at 25° Tilt X_ - Specify Beam ¹	35 - 350 lm/ft 50 - 500 lm/ft 75 - 750 lm/ft 100 - 1,000 lm/ft X_ - Specify lm/ft

3) FIXTURE POWER & CONTROLS

LINE VOLTAGE (DC)	REMOTE DRIVER (POWER) ²	
UNV - 120/277V 347 - 347V	FDND - Factory Non-Dimming FD00 - Factory 0-10V 0.1% Dim FD01 - Factory 0-10V 1% Dim FD10 - Factory 0-10V 10% Dim FDDA - Factory DALI 0.1% Dim FDDX - Factory DMX Dim FDTR - Factory TRIAC Dim LD01 - Lutron Hi-Lume 1% Dim X_ - Specify Driver	Footnotes: ¹ Contact factory about custom beam options. ² Standard driver box is included

4) FIXTURE MOUNTING & CONNECTIONS

WOODWORKS TYPE	MOUNTING KIT	POWER CORD
A1 - Grille Classic A2 - Grille Tegular 9/16" A3 - Grille Tegular 15/16" A4 - Grille Forte A5 - Linear Solid Wood Panels A6 - Linear Veneered Panels A7 - Turf Ceiling	WW225 - XICO Integration Clip Slat Hgt 2.25" WW325 - XICO Integration Clip Slat Hgt 3.25" WW425 - XICO Integration Clip Slat Hgt 4.25" WW40T - XICO Integration Clip Turf UNV	P24W - 24" White Cable Kit P24B - 24" Black Cable Kit

OPTIONAL	
EMERGENCY BACKUP	WIRELESS MODULE
<p>EMC - Emergency Circuit EMB - Emergency Battery (10W — Remote) X_ - Specify Backup</p> <p>Specify requirements at time of order.</p>	<p>WCN - Wireless Communication Node (Connected to LED Driver In-Fixture or In-Driver Box) PIR - Wireless Communication Node + PIR Sensor (Standard Lens for Low Bay < 10') MW - Wireless Communication Node + MW Sensor (Standard for Low Bay < 10') X_ - Other – Specify Embedded Component or Specific Non-Standard Sensor Detection Range</p>

DIMENSIONS & INSTALLATION

Dimensions

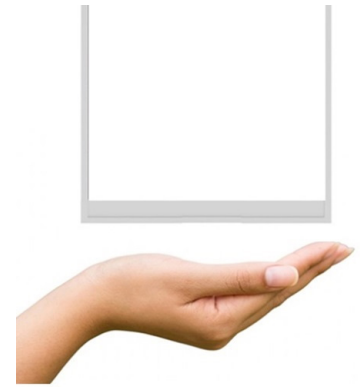
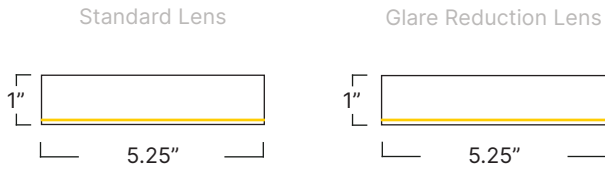

Standard Fixtures

2ft	23.05" / 23.4"
4ft	47.05" / 47.4"
6ft	71.05" / 71.4"
8ft	95.05" / 95.4"

Lens Length / Fixture Length

Mounting Type

Woodworks Integration

Installs into a wood slat cavity via an integration clip. Available with a range of accessories, mounts and inserts that provide easy customization of visual appearance and performance enhancements.

Mounting Options

Mounting Method

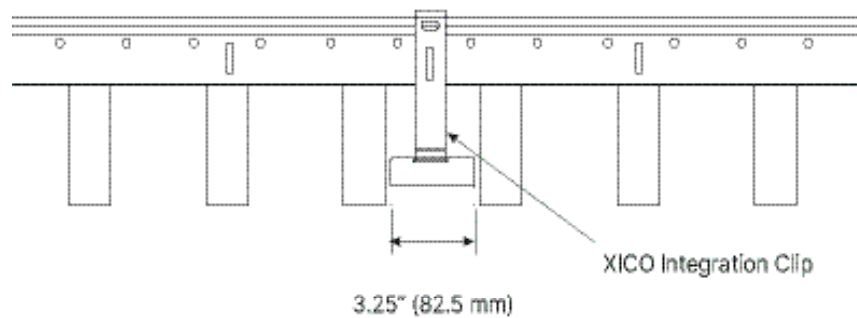

SMARTBEAM® TECHNOLOGY

The Ultimate Control of Lighting Distributions

SmartBeam makes it easy to specify the exact light required for any architectural space. Available in every XICO product; it is now possible to create truly tailored and engaging lighting that transform spaces, improves visual comfort, and saves energy.

To learn more about our SmartBeam Technology, please click or scan the QR Code.



Direct Optics Choices

DIRECT OPTICS	BEAM PATTERN		
	DLAM	DBW65	DA5025
Standard Lens	■	■	■
Glare Reduction Lens	■		

LPW Efficacy Conversion Chart

CODE	CCT SELECTED							
	2200K	2700K	3000K	3500K	4000K	5000K	5700K	6500K
80	–	0.91	0.96	1.00	1.04	1.11	1.11	1.11
90	–	0.91	0.96	1.00	1.04	1.11	1.11	1.11
95	–	0.91	0.96	1.00	1.04	1.11	1.03	1.04
SUN	–	0.90	0.92	1.00	1.01	1.07	1.04	1.05

DIRECT PHOTOMETRICS

Static White Light

48" Length, 80+/3500K CRI/CCT, 3,000 Lumens

DLAM: Lambertian

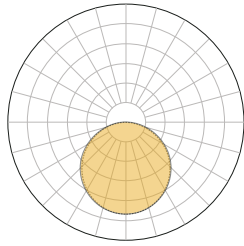

LM/FT	W/FT	LM/W
350	3.2	109.4
500	4.5	111.1
750	6.8	110
1000	9.1	109.9

DBW65: Batwing 65°

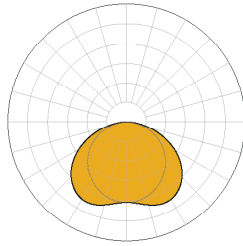

LM/FT	W/FT	LM/W
350	3.2	109.4
500	4.5	111.1
750	6.8	109
1000	9.1	109.9

DA5025: Asymmetric 50° at 25° Tilt

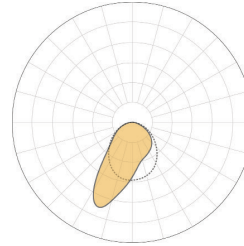

LM/FT	W/FT	LM/W
350	2.5	140
500	3.5	142.9
750	5.3	141
1000	7.1	140.8

OPTICS CONFIGURATIONS

Standard Lens	Glare Reduction Lens
White Standard Lens OSL	White Glare Reduction Lens GRL

COMPATIBLE OPTIC	
FLUSH LENS	GLARE REDUCTION LENS

WELL Building Standard™ and LEED Certification

EDGESolo products are LEED certified and meet the WELL Building Standard™ for low glare (UGR <19) when specified with a low-glare lens option and configured at or below maximum lumen-per-foot output. Refer to the chart below for qualifying configurations and performance data.

LM/FT	EDGESolo			
	ESO200	ESO275	ESO325	ESO525
350				
400				
500				
750				

LED OPTIONS

80: Standard 80+ CRI

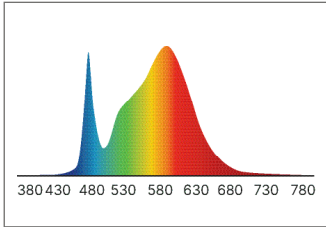

90: Standard 90+ CRI

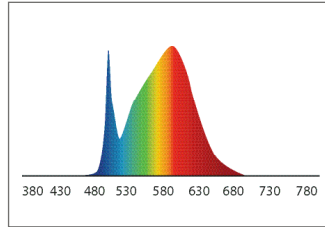

95: High-Definition 95+CRI

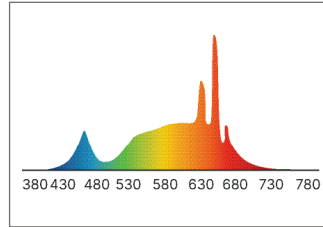

SUN: Full Spectrum "SunLike"

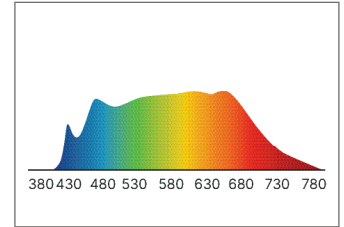

CODE	DESCRIPTION	TYPICAL LED DATA							
		CCT	CRI	CRI R9	TM30 Rf	TM30 Rg	CQS	M/P Ratio	LPW
80	Standard 80 CRI	3500K	82.5	7.8	84	96.7	82.5	0.51	190
90	Standard 90 CRI	3500K	91	54.3	89.3	98.9	89.2	0.55	175
95	High Definition 95 CRI	3500K	97.1	95	-	-	-	0.70	163
SUN	Full Spectrum SunLike®	3500K	95	85	-	-	-	-	130

POWER & CONTROLS

Voltage

Fixture Voltage (AC)

120–277 VAC
347 VAC, 50/60 Hz

Power Location

Remote

LED Driver

Factory Selected, 36–39V Constant Current

Drivers

FDND - Factory Non-Dimming
FD00 - Factory 0-10V 0.1% Dim
FD01 - Factory 0-10V 1% Dim
FD10 - Factory 0-10V 10% Dim
FDDA - Factory DALI 0.1% Dim
FDDX - Factory DMX Dim
FDTR - Factory TRIAC Dim
LD01 - Lutron Hi-Lume 1% Dim
X_ - Specify Driver

Emergency Backup (Optional)

EMC - Emergency Circuit
EMB - Emergency Battery
 (10 W — Remote)
X_ - Specify Backup

Power

10 W

Illumination Time

90 minutes

IP Rating

Suitable for Dry and Damp Locations,
indoor use only

XBox

Remote Driver Boxes (Optional)

To create a clean and organized power solution for multiple fixture installations see our Xbox Specification Guide. Reach out to a XICO Sales Representative to discuss your projects needs.

Compatible Control Options



TECHNICAL SPECIFICATIONS

Finishes & Design Options

Powder Coated Housing Colors (Matte Finish)

- White (RAL9003)
- Black (RAL9005)
- Gray (RAL7001)
- Custom RAL



Housing Material

6063-T5 extruded, recycled aluminum

Mounting Brackets

Sheet Metal

End Cap Material

6063-T5 extruded, recycled aluminum

Lens Options and Material

Standard and Glare Reduction lens options with Patented SmartOptics® made from Acrylic (PMMA)

Standards & Certifications

Sustainability

Low carbon, environmentally conscious packaging and shipping methods

Compliance

BABAA & TAA compliant in-house manufacturing in Boston, MA with North American supply chain



Certifications



Declare Listed and Red List Free

Low carbon, environmentally conscious packaging and shipping methods

Recyclable

SmartOptics and all powder coated and anodized parts are fully recyclable at end of life

Manufacturing

All XICO products and associated optics and LED engines are assembled at our factory in Woburn, MA

Quality Assurance

Each product is engineered for reliability and tested for quality assurance

Declare.

Nano Series
XICO Lighting

Final Assembly: Woburn, MA, USA
Life Span: 50,000+ Hours
End of Life Options: Recyclable (99%)

Ingredients:

Aluminum, Glass, oxides, chemicals, Polymethyl methacrylate, Phenol, 4,4'-[1,1'-methylenebis(4-oxo-1,3-dioxane-2,5-dione)]-2,2'-di(methylmethacrylate) bis(4-phenyleneoxyethylene)bis(2,6-dimethyl-1,3-dioxane-5-carboxylic acid), 1,3-diphenyl ethane polymer with 1,4-dimethyl (4-benzenedicarboxylate and 1,2-ethanedithiol, Polyethylene Glycol, Polyethylene Terephthalate, Barium sulfate, Magnesium, Silicon, Phosphoric acid, di-nitrophenyl ester iron, Silver and Silver, di-Nickel, Chromium, metallic, Gold, Manganese, Titanium, Zinc, Nickel, (metallic)

Declare Listed

At Xico Lighting, we are committed to transparency and sustainability. That's why all our products are Declare listed, providing clear insights into their environmental footprint and safety. Look for these internationally recognized labels on Xico products, packaging, or at xicoled.com/declare.



Red List Free

Xico Lighting is dedicated to creating safe, sustainable solutions. All our products are Red List Free, meeting the highest industry standards for healthy and environmentally responsible materials as defined by the International Living Future Institute (ILFI). Learn more at xicoled.com/declare.

Quick Links

5-YR Warranty



Business Terms



Patents & Trademarks



SmartBeam



Revit Files

