

PROBeam4 Surface

Direct | Standard Lengths



Project Name _____

Fixture Type _____

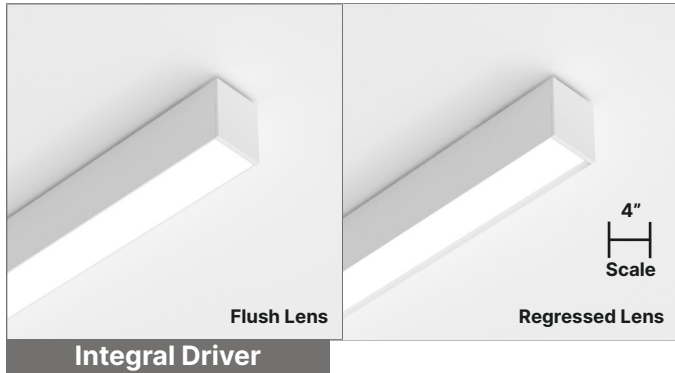

DESCRIPTION

4" High-Performance Linear LED Surface Mount

PROBeam4 Surface brings SmartBeam® capabilities to a 4" surface-mounted form factor with an integral driver providing best-in-class efficiency and beam control options. The PROBeam4 Surface is designed to be specification grade with a wide range of beam options, high CRI, and circadian options. The 4" aperture delivers comfortable illumination in a wide range of beam distributions while achieving high efficacy, and energy-saving performance. PROBeam4 Surface also comes with a choice of integral drivers and controls as well as a wide range of lumen outputs and beam distributions.

LIGHTING CONFIGURATIONS

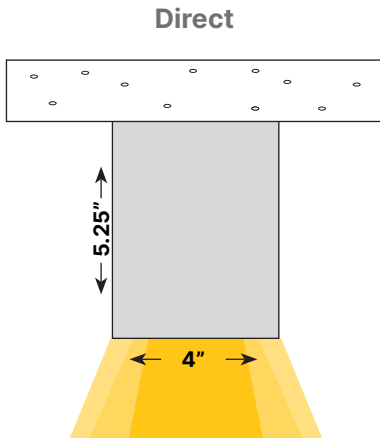

FEATURES & BENEFITS

Exceptional Performance

Up to 1,500 lm/ft, 150 lm/W efficacy

Wide Range of LED Selections

Static, Tunable White, and Dim-to-Warm

Designed with Options

Wide choice of SmartOptic® lenses, beam distributions, 80/90/95+ CRI, 2700K to 6500K CCT, and 0-10V, DALI, DMX, and TRIAC dimming

Patented Innovations

Fusion® Optix Inside with unique SmartBeam® capabilities

Proprietary Optical Components

Provides excellent light distribution and high-transmission

Committed to Sustainability

Declare Listed and Red Free List materials

Compliance

UL Listed, Dry and Damp Locations

5-Year Warranty

Standard 5-year warranty, 50,000 hours



FIXTURE ORDERING

Project Name _____ Fixture Type _____

1) FIXTURE DESIGN

PRODUCT	FIXTURE LENGTH	FINISH	END CAP STYLE
PBE4-S 4" High-Performance Linear LED Surface Mount	2 - 2 ft 4 - 4 ft 6 - 6 ft 8 - 8 ft X_ - Specify Ft', In"	Powder Coated PMW - Matte White PMB - Matte Black PMG - Matte Gray PRAL_ - Specify RAL #	E1 - Flat End Cap
	Custom fixtures are available in 3" increments beyond standard lengths.	Anodized ACL - Clear Anodized ACU_ - Custom Anodized #	

2) LED LIGHT ENGINE

CRI	CCT	OPTIC (DIRECT ONLY)	DIRECT BEAM PATTERN	DIRECT OUTPUT
80 - Std. 80 CRI 90 - Std. 90 CRI 95 - High-Def. 95 CRI SUN - Full SunLike	27 - 2700K 30 - 3000K 35 - 3500K 40 - 4000K XD - Dim-to-Warm XT - Tunable X_ - Specify CCT Specify Dim-to-Warm and Tunable between 2700K-6500K.	OFL - Flush Lens ORL - Regressed Lens OCRL - Continuous Regressed Lens ¹	DLAM - Lambertian DBW60 - Batwing 60° DDA70 - Double Asym 70° DA5025 - Asym 50° at 25° Tilt DA4005 - Asym 40° at 5° Tilt DM55 - Medium 55° DN40 - Narrow 40° X_ - Specify Beam ²	35 - 350 lm/ft 50 - 500 lm/ft 75 - 750 lm/ft 100 - 1,000 lm/ft X_ - Specify lm/ft

3) FIXTURE POWER & CONTROLS

LINE VOLTAGE (DC)	INTEGRAL DRIVER (POWER) ³
UNV - 120/277V 347 - 347V	FDND - Factory Non-Dimming FD00 - Factory 0-10V 0.1% Dim FD01 - Factory 0-10V 1% Dim FD10 - Factory 0-10V 10% Dim FDDA - Factory DALI 0.1% Dim FDDX - Factory DMX Dim FDTR - Factory TRIAC Dim LD01 - Lutron Hi-Lume 1% Dim X_ - Specify Driver

Footnotes: ¹Continuous Regressed Lens ships on a roll for seamless lens installation. ²Contact factory about custom beam options. ³Standard driver box is included

4) FIXTURE MOUNTING & CONNECTIONS

MOUNTING TYPE	MOUNTING KIT
SC1 - Surface Mount Clip TC1 - 9/16" Flat T-Bar Mount TC2 - 9/16" Bolt Slot T-Bar Mount TC3 - 15/16" Flat T-Bar Mount TC1, TC2 and TC3 clips directly to grid t-bar.	SSMB - Stainless Steel Surface Mounting Bracket

OPTIONAL	
EMERGENCY BACKUP	WIRELESS MODULE
<p>EMC - Emergency Circuit EMB - Emergency Battery (10 W — Remote) X_ - Specify Backup</p> <p>Specify requirements at time of order.</p>	<p>WCN - Wireless Communication Node (Connected to LED Driver In-Fixture or In-Driver Box) PIR - Wireless Communication Node + PIR Sensor (Standard Lens for Low Bay < 10') MW - Wireless Communication Node + MW Sensor (Standard for Low Bay < 10') X_ - Other – Specify Embedded Component or Specific Non-Standard Sensor Detection Range</p>

DIMENSIONS & INSTALLATION

Dimensions

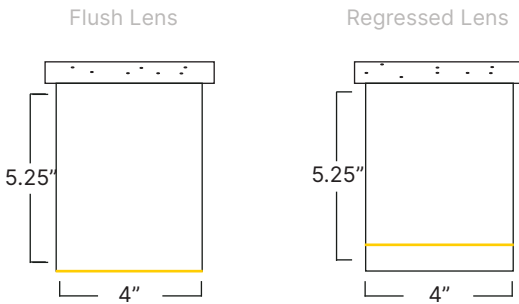

Standard Fixtures

2ft	23.05" / 23.4"
4ft	47.05" / 47.4"
6ft	71.05" / 71.4"
8ft	95.05" / 95.4"

Lens Length / Fixture Length

Mounting Type

T-Bar Mount

Installs into a ceiling grid system and mount on to, or replace, typical T-Bar elements. Available with a range of accessories, mounts and inserts that provide easy customization of visual appearance and performance enhancements.

Surface Mount

Installs onto a surface. Available with a range of accessories, mounts and inserts that provide easy customization of visual appearance and performance enhancements.

Mounting Type

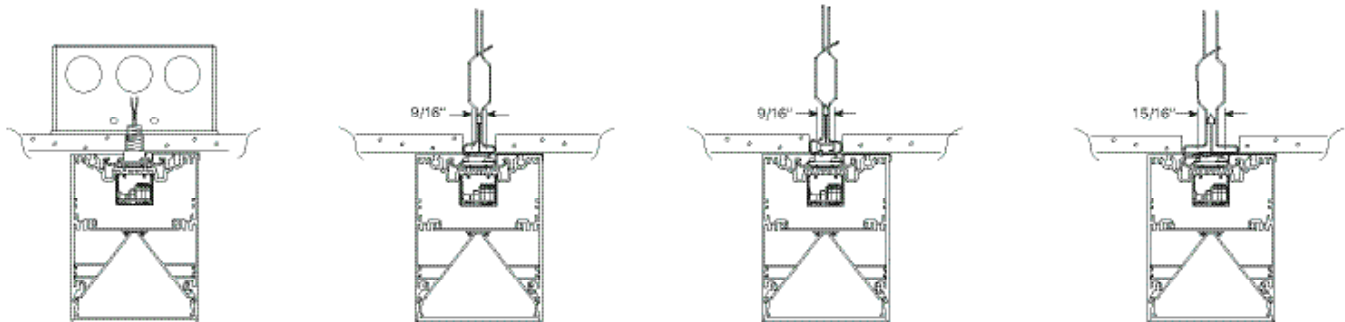

DJ - Drywall/J-Box Mount

T1 - 9/16" Flat T-Bar Mount

T2 - 9/16" Bolt Slot T-Bar Mount

T3 - 15/16" Flat T-Bar Mount

SMARTBEAM® TECHNOLOGY

The Ultimate Control of Lighting Distributions

SmartBeam makes it easy to specify the exact light required for any architectural space. Available in every XICO product; it is now possible to create truly tailored and engaging lighting that transform spaces, improves visual comfort, and saves energy.

To learn more about our SmartBeam Technology, please click or scan the QR Code.



Direct Optics Choices

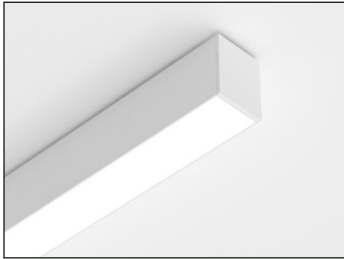

FL - Flush Lens

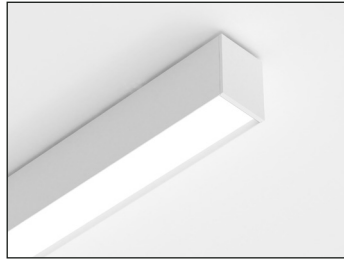

RL - Regressed Lens

DIRECT OPTICS	BEAM PATTERN						
	DLAM	DBW60	DDA70	DA5025	DA4005	DM55	DN40
Flush Lens	■	■	■	■	■	■	■
Regressed Lens	■	■	■	■	■	■	■

LPW Efficacy Conversion Chart

CODE	CCT SELECTED							
	2200K	2700K	3000K	3500K	4000K	5000K	5700K	6500K
80	-	0.91	0.96	1.00	1.04	1.11	1.11	1.11
90	-	0.91	0.96	1.00	1.04	1.11	1.11	1.11
95	-	0.91	0.96	1.00	1.04	1.11	1.03	1.04
SUN	-	0.90	0.92	1.00	1.01	1.07	1.04	1.05

LPW Performance

	DIRECT						
	DLAM	DBW60	DDA70	DA5025	DA4005	DM55	DN40
LM/W	142	145	138	143	139	137	136

$$LM/W = \frac{\left(\begin{matrix} \text{DIRECT} \\ \text{LM/FT} \end{matrix} + \begin{matrix} \text{INDIRECT} \\ \text{LM/FT} \end{matrix} \right)}{\left(\begin{matrix} \text{DIRECT} \\ \text{W/FT} \end{matrix} + \begin{matrix} \text{INDIRECT} \\ \text{W/FT} \end{matrix} \right)}$$

DIRECT PHOTOMETRICS

48" Length, 80+/3500K CRI/CCT, 3,000 Lumens

Static White Light

DLAM: Lambertian

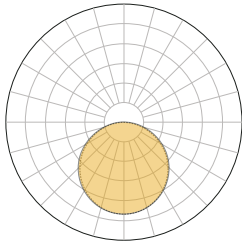

LM/FT	W/FT	LM/W
350	2.5	140
500	3.5	143
750	5.3	142
1000	7.0	143

DBW60: Batwing 60°

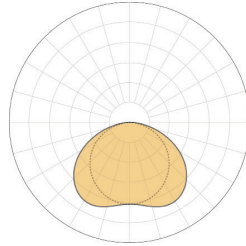

LM/FT	W/FT	LM/W
350	2.4	145.8
500	3.5	143
750	5.2	145
1000	6.9	144.9

DDA70: Double Asymmetric 70°

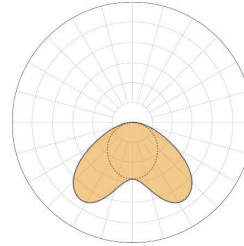

LM/FT	W/FT	LM/W
350	2.5	140
500	3.6	138.9
750	5.4	138
1000	7.2	138.9

DA5025: Asymmetric 50° at 25° Tilt

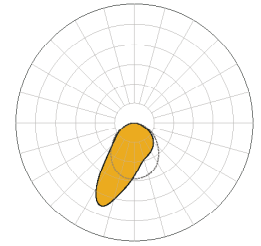

LM/FT	W/FT	LM/W
350	2.4	145.8
500	3.5	142.9
750	5.2	143
1000	6.9	144.9

DA4005: Asymmetric 40° at 5° Tilt

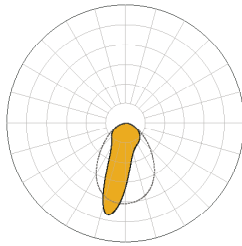

LM/FT	W/FT	LM/W
350	2.5	140
500	3.6	138.9
750	5.4	139
1000	7.2	138.9

DM55: Medium 55°

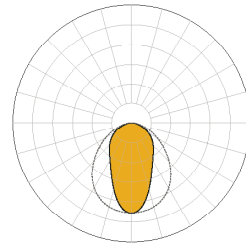

LM/FT	W/FT	LM/W
350	2.6	134.6
500	3.7	135.1
750	5.5	137
1000	7.3	137

DN40: Narrow 40°

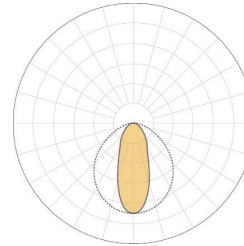

LM/FT	W/FT	LM/W
350	2.6	134.6
500	3.7	135.1
750	5.5	136
1000	7.3	137

COMPATIBLE OPTIC	
FLUSH LENS	REGRESSED LENS

OPTICS CONFIGURATIONS

Flush Lens	Regressed Lens	Continuous Regressed Lens
White Flush Lens OFL	White Regressed Lens ORL	White Regressed Lens OCRL

LED OPTIONS

80: Standard 80+ CRI

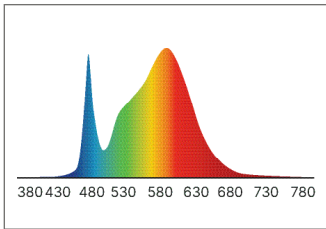

90: Standard 90+ CRI

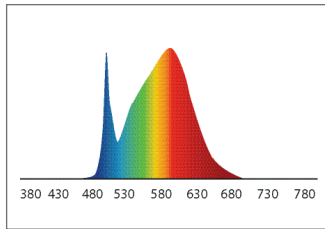

95: High-Definition 95+CRI

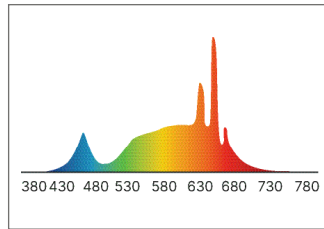

SUN: Full Spectrum "SunLike"

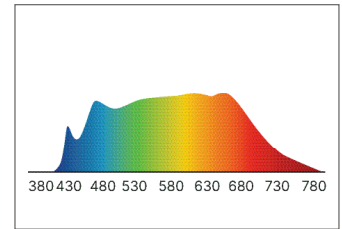

CODE	DESCRIPTION	TYPICAL LED DATA							
		CCT	CRI	CRI R9	TM30 Rf	TM30 Rg	CQS	M/P Ratio	LPW
80	Standard 80 CRI	3500K	82.5	7.8	84	96.7	82.5	0.51	190
90	Standard 90 CRI	3500K	91	54.3	89.3	98.9	89.2	0.55	175
95	High Definition 95 CRI	3500K	97.1	95	-	-	-	0.70	163
SUN	Full Spectrum SunLike®	3500K	95	85	-	-	-	-	130

POWER & CONTROLS

Voltage

Fixture Voltage (AC)

120–277 VAC
347 VAC, 50/60 Hz

Power Location

Integral

LED Driver

Factory Selected, 36–39V Constant Current

Drivers

FDND - Factory Non-Dimming
FD00 - Factory 0-10V 0.1% Dim
FD01 - Factory 0-10V 1% Dim
FD10 - Factory 0-10V 10% Dim
FDDA - Factory DALI 0.1% Dim
FDDX - Factory DMX Dim
FDTR - Factory TRIAC Dim
LD01 - Lutron Hi-Lume 1% Dim
X_ - Specify Driver

Emergency Backup (Optional)

EMC - Emergency Circuit
EMB - Emergency Battery
 (10 W — Remote)
X_ - Specify Backup

Power

10 W

Illumination Time

90 minutes

IP Rating

Suitable for Dry and Damp Locations,
indoor use only

XBox

Remote Driver Boxes (Optional)

To create a clean and organized power solution for multiple fixture installations see our Xbox Specification Guide. Reach out to a XICO Sales Representative to discuss your projects needs.

Compatible Control Options



TECHNICAL SPECIFICATIONS

Finishes & Design Options

Housing Colors (Matte Finish)

- White (RAL9003)
- Black (RAL9005)
- Gray (RAL7001)
- Custom RAL



Housing Material

6063-T5 extruded, recycled aluminum

Mounting Brackets

Sheet Metal

Flat End Cap Material

Machined or cast aluminum

Lens Options and Material

Flush, Regressed, and Continuous Regressed lens options with Patented SmartOptics® made from Acrylic (PMMA)

Standards & Certifications

Sustainability

Low carbon, environmentally conscious packaging and shipping methods

Compliance

BABAA & TAA compliant in-house manufacturing in Boston, MA with North American supply chain



Certifications



Declare Listed and Red List Free

Low carbon, environmentally conscious packaging and shipping methods

Recyclable

SmartOptics and all powder coated and anodized parts are fully recyclable at end of life

Manufacturing

All XICO products and associated optics and LED engines are assembled at our factory in Woburn, MA

Quality Assurance

Each product is engineered reliability and quality assurance tested

Declare.

Nano Series
XICO Lighting

Final Assembly: Woburn, MA, USA
Life Expectancy (in Years):
End of Life Options: Recyclable (99%)

Ingredients:
Aluminum, Steel, oxide, chemicals, Poly(methyl methacrylate), Phenol, 4,4'-[1-methyl-4-phenylene]bis-, polymer with 2,2'-(3,3',5,5'-tetramethyl-4,4'-diphenylene)bis(methylene)bis[2,6-dimethyl-1,3-dioxane-5-carboxylic acid, 1,3-dimethyl ester, polymer with 1,4-dimethyl-1,3-bis(methylene)bis(oxalate) and 1,2-ethanediol, Polyethylene, Copper, Polyethylene Terephthalate, Barium sulfate, Magnesium, Silicon, Propylgallate, phosphoric acid, aliphatic ester, Iron, Siloxanes and Silicones, di-Mn, Chromium, metallic, Gold, Manganese, Titanium, Zinc, Nickel (plastic)

Declare Listed

At Xico Lighting, we are committed to transparency and sustainability. That's why all our products are Declare listed, providing clear insights into their environmental footprint and safety. Look for these internationally recognized labels on Xico products, packaging, or at xicoled.com/declare.



Red List Free

Xico Lighting is dedicated to creating safe, sustainable solutions. All our products are Red List Free, meeting the highest industry standards for healthy and environmentally responsible materials as defined by the International Living Future Institute (ILFI). Learn more at xicoled.com/declare.

Quick Links

5-YR Warranty

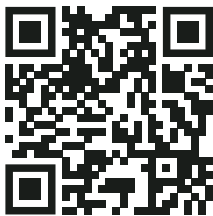

Business Terms

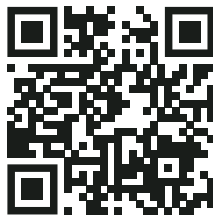

Patents & Trademarks

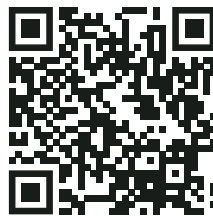

SmartBeam

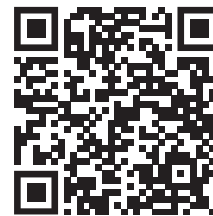

Revit Files

