

MICROBeam MCO Surface

1.4" Low-Profile Linear LED Surface Mount

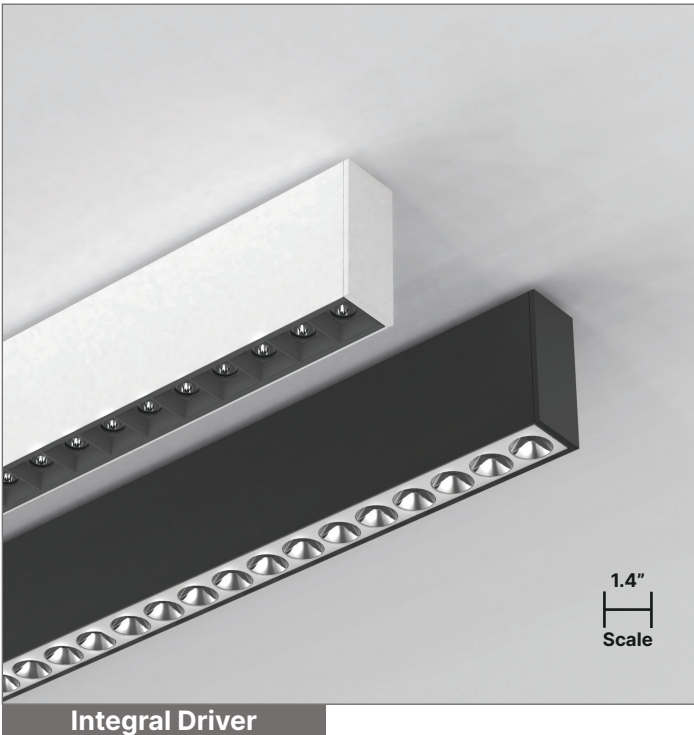

Features & Benefits

Exceptional Performance

Up to 1,000 lm/ft, 150 lm/W efficacy

Wide Range of LED Selections

Static, Tunable White, and Dim-to-Warm

Designed with Options

Wide choice of SmartOptic® lenses, beam distributions, 80/90/95+ CRI, 2200K to 5000K CCT, and 0-10V, DALI, DMX, and TRIAC dimming

Patented Innovations

Fusion® Optix Inside with unique SmartBeam® capabilities

Proprietary Optical Components

Provides excellent light distribution and high-transmission

Committed to Sustainability

Declare Listed and Red Free List materials

Compliance

UL Listed, Dry and Damp Locations

5-Year Warranty

Standard 5-year warranty, 50,000 hours

Designed & Built in
BOSTON

Declare



FIXTURE ORDERING

Project Name

1) FIXTURE DESIGN

Fixture Type

PRODUCT	LENGTH	FIXTURE FINISH	END CAP	MICRO CAVITY OPTICS (MCO) FINISH
MBE140MCO-S				
1.4" Low-Profile	2 2'	MWH Matte White (RAL9003)	E1 Flat End Cap	OSQMCOWH Square MCO, White
Linear LED	4 4'	MBK Matte Black (RAL9005)		OSQMCOBK Square MCO, Black
Surface Mount	6 6'	MGR Matte Gray (RAL7001)		ORMCOWH Round MCO, White
	8 8'	CAE Clear Anodized Effect		ORMCOBK Round MCO, Black
	10 10'	RAL_ Specify RAL#		
	X_ Specify X', Y"			

2) LED LIGHT ENGINE

CRI	CCT	DIRECT BEAM PATTERN	DIRECT OUTPUT
S80 Std. 80 CRI	22 2200K	DMCO45 Micro Cavity Optics 45°	35 350 lm/ft
S90 Std. 90 CRI	27 2700K	DMCO35 Micro Cavity Optics 35°	50 500 lm/ft
HE80 High-Eff. 80 CRI	30 3000K	DMCO25 Micro Cavity Optics 25°	75 750 lm/ft
HE90 High-Eff. 90 CRI	35 3500K	X_ Specify Beam	100 1,000 lm/ft
HD95 High-Def. 95 CRI	40 4000K		X_ Specify lm/ft
SUN Full SunLike	50 5000K		
SBIOS Static BIOS	3022D 3000K to 2200K Dim-to-Warm		
DBIOS Dynamic BIOS	3527D 3500K to 2700K Dim-to-Warm		
TBIOS Tunable White BIOS	X_ Specify CCT		

3) FIXTURE POWER & CONTROLS

LINE VOLTAGE (DC)	INTEGRAL DRIVER (POWER)	EMERGENCY BACKUP	CONTROL SYSTEM ²
UNV 120/277V	FDND Factory Non-Dimming	NN Not Needed	NN Not Needed
347 347V	FD01 Factory 0-10V 1% Dim	EMC Emergency Circuit	LUT Lutron
	FD10 Factory 0-10V 10% Dim	EMB Emergency Battery (10 W — Onboard)	COO Cooper
	FDDA Factory DALI 0.1% Dim	X_ Specify Backup	CAS Casambi
	FDDX Factory DMX Dim		X_ Specify Control System
	FDTR Factory TRIAC Dim		
	LD01 Lutron Hi-Lume 1% Dim		
	LD05 Lutron 5-Series 5% Dim		
	ED00 eldoLED 0-10V 0.1% Dim		
	ED01 eldoLED 0-10V 1% Dim		
	EDDA eldoLED DALI 0.1% Dim		
	X_ Specify Driver		

4) FIXTURE MOUNTING & CONNECTIONS

MOUNTING TYPE	POWER CORD	MOUNTING KIT
DJ Drywall/J-Box Mount	S24WH 24" White Cable Kit	SSMB Stainless Steel Surface Mounting Bracket
T1 9/16" Flat T-Bar Mount	S24BK 24" Black Cable Kit	
T2 9/16" Bolt Slot T-Bar Mount		
T3 15/16" Flat T-Bar Mount		

NOTES

Footnotes: ¹ Continuous Regressed Lens ships on a roll for seamless lens installation. ² The control system and driver must be compatible.

FIXTURE DESIGN

Dimensions



To download BIM (Revit) Files, please click or scan the QR Code.

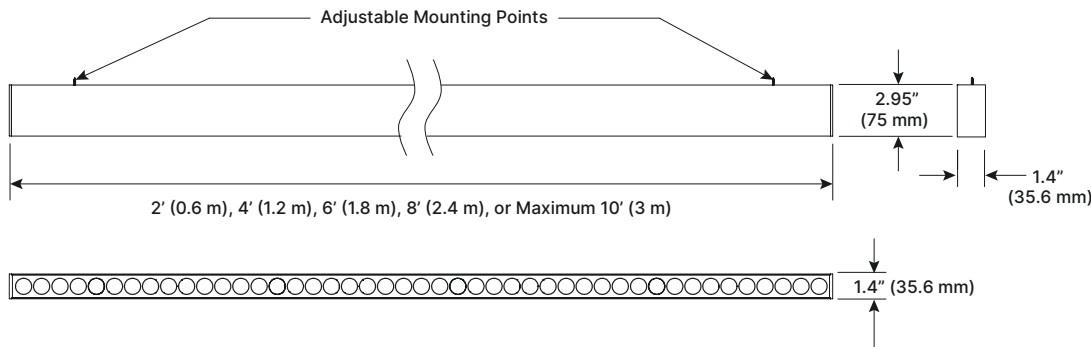

Length

Length Options 2', 4', 6', 8', 10' nominal, or custom within 3"

Finish

Housing Colors (Matte Finish)



White (RAL9003)



Black (RAL9005)



Gray (RAL7001)



Clear Anodized Effect



Custom RAL

Housing Material 6063-T5 extruded, recycled aluminum

Mounting Brackets Sheet metal

End Cap

End Cap Option Flat

End Cap Material Machined or cast aluminum

Optic

Lens Options Square and Round Micro Cavity Optics

Lens Material Patented SmartOptics® made from Acrylic (PMMA)

Voltage

Fixture Voltage (AC) 120–277 VAC and 347 VAC, 50/60 Hz

LED SELECTION GUIDE

S80: Standard 80+ CRI

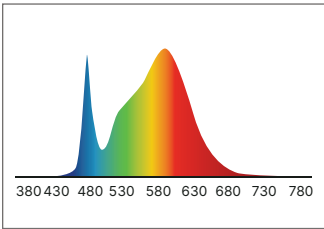

S90: Standard 90+ CRI

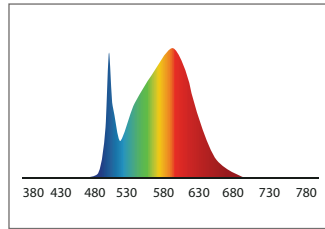

HE80: High-Efficiency 80+ CRI

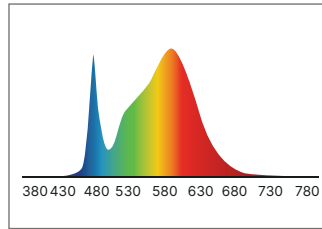

HE90: High-Efficiency 90+ CRI

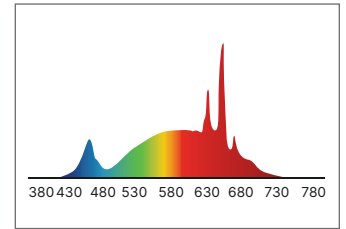

HD95: High-Definition 95+ CRI

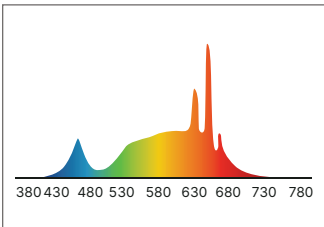

SUN: Full Spectrum "SunLike"

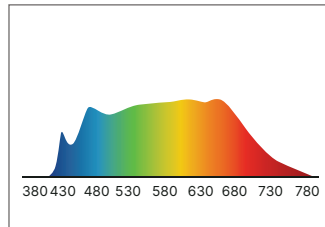

HCD: Human Centric Day

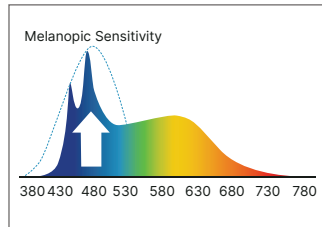

HCN: Human Centric Night

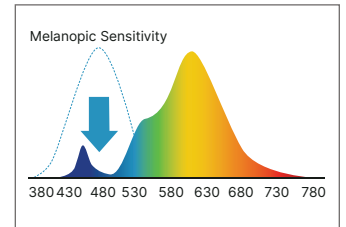

Static White Light (LED Light Engine Only)

CODE	DESCRIPTION	TYPICAL LED DATA							
		CCT	CRI	CRI R9	TM30 Rf	TM30 Rg	CQS	M/P Ratio	LPW
S80	Standard 80 CRI	3500K	82.5	7.8	84	96.7	82.5	0.51	190
S90	Standard 90 CRI	3500K	91	54.3	89.3	98.9	89.2	0.55	175
HE80	High Efficiency 80 CRI	3500K	82.1	5.9	83	94.2	81.2	0.52	210
HE90	High Efficiency 90 CRI	3500K	92.2	90	90.7	103.8	92.1	0.56	190
HD95	High Definition 95 CRI	3500K	97.1	95	-	-	-	0.70	163
SUN	Full Spectrum SunLike®	3500K	95	85	-	-	-	-	130
HCD	Human Centric Day	4000K	83	95	-	-	-	0.92	155
HCN	Human Centric Night	2700K	80	-	-	-	-	0.44	134

LPW Efficacy Conversion Chart

CODE	CCT SELECTED							
	2200K	2700K	3000K	3500K	4000K	5000K	5700K	6500K
S80	-	0.91	0.96	1.00	1.04	1.11	1.11	1.11
S90	-	0.91	0.96	1.00	1.04	1.11	1.11	1.11
HE80	-	0.96	0.99	1.00	1.03	1.04	1.03	1.03
HE90	-	0.91	0.96	1.00	1.04	1.11	N/A	N/A
HD95	-	0.91	0.96	1.00	1.04	1.11	1.03	1.04
SUN95	-	0.90	0.92	1.00	1.01	1.07	1.04	1.05
HCD	-	N/A	0.96	1.00	1.04	1.04	1.04	1.04
HCN	-	0.87	0.96	1.00	1.04	N/A	N/A	N/A

BIOS TECHNOLOGY

Choosing Your BIOS Solution

BIOS is offered in four Circadian LED Solutions with BIOS SkyBlue Technology — Biological Static, Biological Dynamic, Biological Tunable, and Biological Dim-to-Warm. BIOS SkyBlue™ Technology includes a blue peak at 490nm that provides an effective daytime circadian signal using standard architectural color temperatures.



To learn more about BIOS Technology, please click or scan the QR Code.



BIOS Static

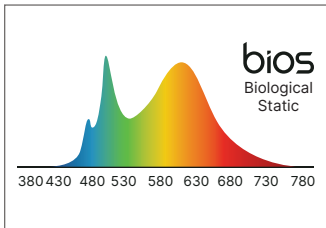

BIOS Dynamic

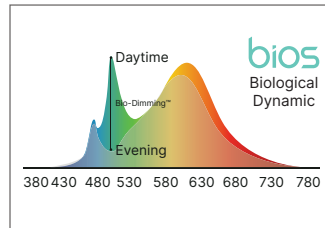

BIOS Tunable

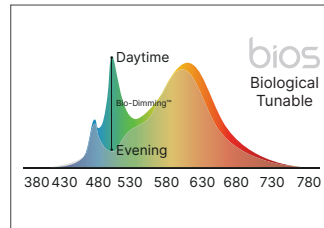

BIOS Dim-to-Warm

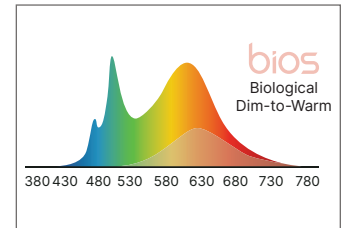

Daytime

No color change when dimmed

Spaces that operate during daytime hours — 7am and 7pm

Daytime & Evening

500K shift when dimmed

Spaces that operate overnight — after 7pm and before 7am

Daytime & Evening

Dims to 2700K

Spaces that operate with overnight shifts — after 7pm and before 7am

Daytime & Evening

Dims from cool to warm

Spaces where people sleep — after 7pm and before 7am

Circadian and Human Centric Light

CODE	DESCRIPTION	BIO-DIMMING MODULE TECHNOLOGY GUIDE					
		Driver	Driver Voltage	CCT	Requires BIO-Dimming Module	Lighting Control	BIOS SkyBlue (490nm)
SBIOS	BIOS Static	DIM1	0-10V Dimming to 1% Dim-to-Dark	No CCT Change	No	Intensity Dimming Control Only	Always Present
DBIOS	BIOS Dynamic	BIODIM1	0-10V Intensity Dimming to 1% Dim-to-Dark	500K Shift	Yes	Intensity Dimming & Spectrum Change Controlled Together	Removed with BIO-Dimming
DBIOS-2	BIOS Dynamic (Two Channel)				No	Intensity Dimming & Spectrum Change Controlled Separately	Removed by Adjusting "Spectrum Channel"
TBIOS	BIOS Tunable	ATW / DTW	0-10V Control of Intensity & CCT on Separate 2 Channels / DALI Control of Intensity & CCT on Separate 2 Channels	Dims to 2700K	Yes	Intensity Dimming & Spectrum Change Controlled Together	Removed with BIO-Dimming
TBIOS-2	BIOS Tunable (Two Channel)				No	Intensity Dimming & Spectrum Change Controlled Separately	Removed by Adjusting "Spectrum Channel"
DWBIOS	BIOS Dim-to-Warm	-	-	Dims to 2200K	Yes	Intensity Dimming & Spectrum Change Controlled Together	Removed with BIO-Dimming
DWBIOS-2	BIOS Dim-to-Warm (Two Channel)				No	Intensity Dimming & Spectrum Change Controlled Separately	Removed by Adjusting "Spectrum Channel"

SMARTBEAM® TECHNOLOGY

The Ultimate Control of Lighting Distributions

SmartBeam makes it easy to specify the exact light required for any architectural space. Available in every XICO product; it is now possible to create truly tailored and engaging lighting that transform spaces, improves visual comfort, and saves energy.

To learn more about our SmartBeam Technology, please click or scan the QR Code.



FIXTURE POWER & CONTROLS

Voltage

LED Driver Factory Selected, 36–39V Constant Current

Emergency Backup

Backup Types Emergency Circuit, Emergency Battery (Onboard), and other emergency backups are available

Wiring Typically the Emergency Backup is wired to 48" sections

Power 10 W

Illumination Time 90 minutes

Partners



Control Systems

Other Factory Non-Dimming, Factory 0–10V 1% Dim, Factory 0–10V 10% Dim, Factory DALI 0.1% Dim, Factory DMX Dim, Factory TRIAC Dim, eldoLED 0–10V 0.1% Dim, eldoLED 0–10V 1% Dim, eldoLED DALI 0.1% Dim, and other drivers are available, consult factory (not all integral)

Lutron Hi-Lume 1% Dimming and 5-Series 5% Dimming

Cooper Compatible driver

Casambi (wireless) Compatible driver

Integral Drivers

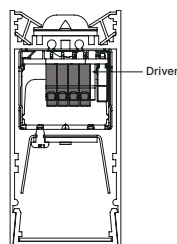

Drivers are integral to the fixture and are included. They provide 0–10V, DALI, DMX, and TRIAC dimming. Also compatible with Cooper and other common building control systems, including PoE and wireless.

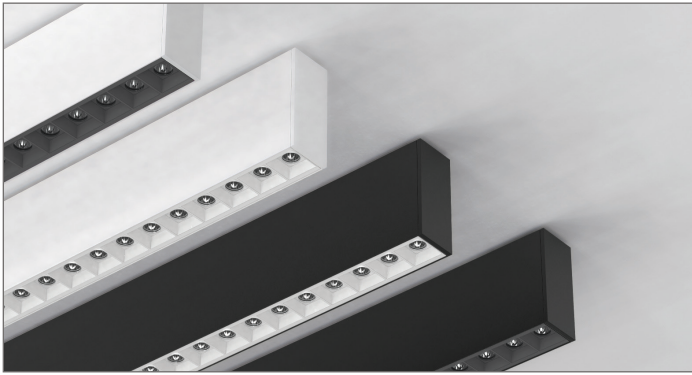

Square MCOs

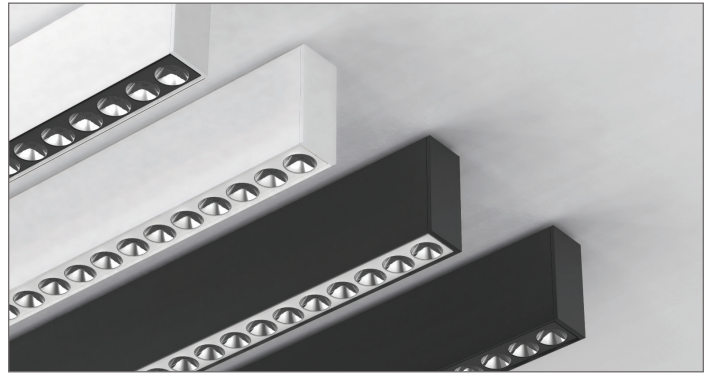

Round MCOs

FIXTURE MOUNTING & CONNECTIONS

Mounting Type

T-Bar Mount

Installs into a ceiling grid system and mount on to, or replace, typical T-Bar elements. Available with a range of accessories, mounts and inserts that provide easy customization of visual appearance and performance enhancements.

Drywall/J-Box Mount

Installs onto a surface via a junction box. Available with a range of accessories, mounts and inserts that provide easy customization of visual appearance and performance enhancements.

Power Cords

24" Cable Kit

White and Black

Mounting Kit

Surface Mounting Bracket

Stainless Steel

Mounting Options

DJ - Drywall/J-Box Mount

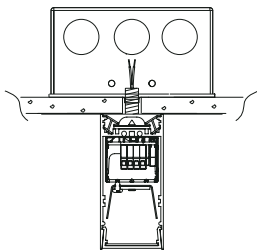

T1 - 9/16" Flat T-Bar Mount

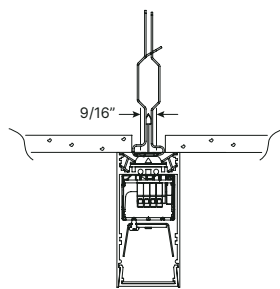

T2 - 9/16" Bolt Slot T-Bar Mount

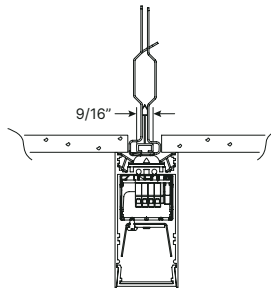

T3 - 15/16" Flat T-Bar Mount

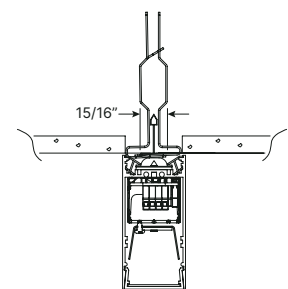

Standard Lengths & Continuous Runs

Maximum length of one fixture is 10'. Longer runs can be produced by joining sections. Customer approval of shop drawings is required prior to build of any non-standard length order.

Lens can be supplied in a maximum 250' roll length with Continuous FlatLENS Optics to be installed on-site for a seamless light surface.

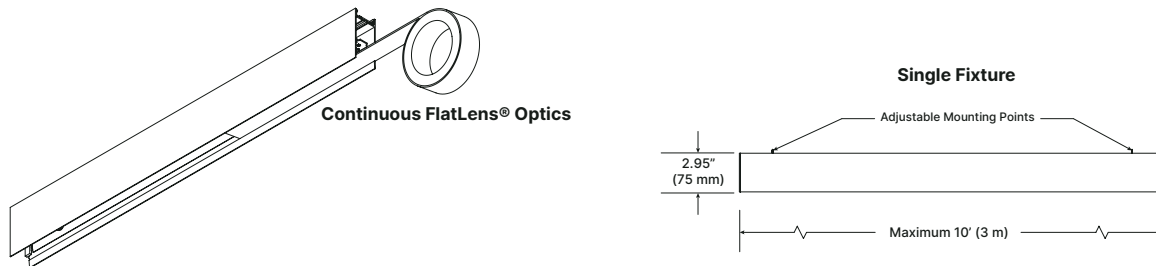

Standard Continuous Run

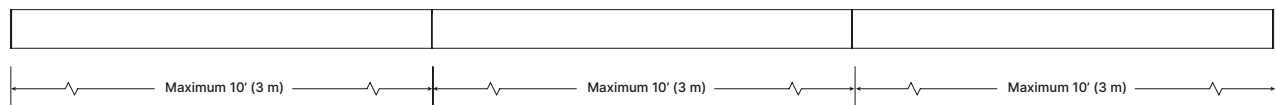

Emergency Battery Backup

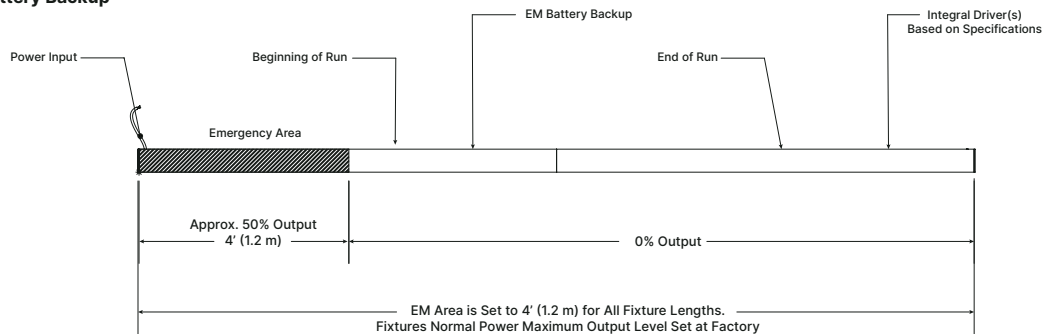

Battery Power: 10 W
 Illumination Time: 90 minutes
 Light Output approx 300 lm/ft or 1200-1300 Total Lumens*
 Recharge Time: 24 Hours

*Light output may vary based on fixture output level ordered.

STANDARDS & CERTIFICATIONS

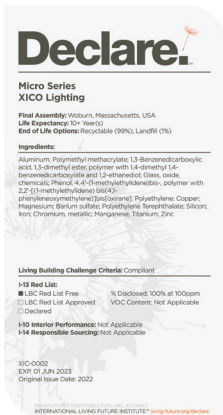

Declare Listed

Declare labels provide a quick and reliable way to make choices about the environmental footprint and safety of the product. Declare is internationally recognized and the labels can be found on the product, product packaging, or company website. Visit xicoled.com for Declare Listed details.



Red List Free

An industry standard certification for LED lighting products based on the International Living Future Institute (ILFI). These products only use materials based on the “Red List of Toxic Chemicals” (a list of chemicals and materials known to be hazardous to people and/or the Earth) that are safe, healthy, and environmentally sustainable.

Certifications

Compliance

BAA & TAA compliant in-house manufacturing in Boston, MA with North American supply chain

Certifications



Sustainability

Declare Listed and Red List Free

Packaging

Low carbon, environmentally conscious packaging and shipping methods

Environmental Suitability

IP Rating

Suitable for Dry and Damp Locations, indoor use only

Recyclable

SmartOptics and all powder coated and anodized parts are fully recyclable at end of life

Reliability

Manufacturing

All XICO products and associated optics and LED engines are assembled at our factory in Woburn, MA

Quality Assurance

Each product is engineered reliability and quality assurance tested

Warranty & Terms

5-YR Warranty

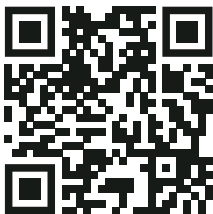

Business Terms



For details on our warranty and business terms, please click or scan the QR Code.

OPTIC			
	DMCO45	DMCO35	DMCO25
Micro Cavity Optics (MCO)	●	●	●

DIRECT PHOTOMETRICS

Static White Light

DMCO45: Micro Cavity Optic 45°

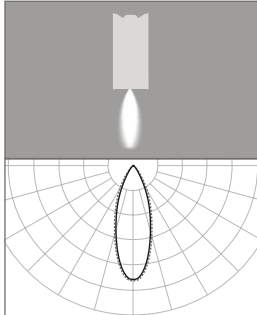

Length 48"
LED HE80
CRI/CCT 80+/3500K
Lumens 3,000
lm/ft 749
Watts 37
W/ft 9
LPW 82

DMCO35: Micro Cavity Optic 35°

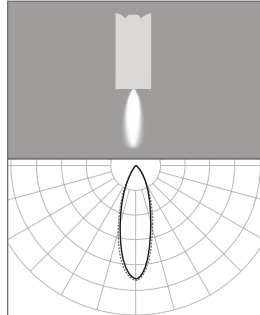

Length 48"
LED HE80
CRI/CCT 80+/3500K
Lumens 3,000
lm/ft 749
Watts 37
W/ft 9
LPW 82

DMCO25: Micro Cavity Optic 25°

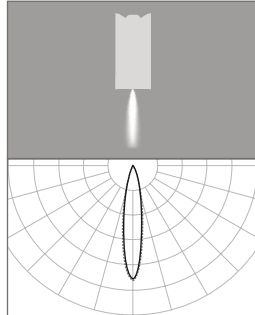

Length 48"
LED HE80
CRI/CCT 80+/3500K
Lumens 3,000
lm/ft 749
Watts 37
W/ft 9
LPW 82

PATENTS & TRADEMARKS



To learn more about our unique technologies, please click or scan the QR Code.

Utility Patents

United States	US11543582, US11520097, US11512466, US11441749, US11396751, US11333822, US11163104, US11156762, US10852466, US10068447, US8953926, US8948564, US8911099, US8876348, US8794812, US8783898, US8761565, US8750671, US8721152, US8619363, US8430548, US8408775, US8249408, US8231256, US8177408, US8033706, US8033674, US7991257, US7914192, US7784954, US7758227, US7722224, US7542635, US7453636, US7453635, US7431489, US7408707, US7278775, US6369944, US6346311, US6123877, US5932342, US5837346, US20220373144, US20220372752, US20220364708, US20220357006, US20220357005, US20220342141, US20220290432, US20220206210A1, US20220171119A1, US20220171115A1, US20220162856A1, US20220162853A1, US20220146063A1, US20220137287, US20210301991A1, US20200355345A1, US20200217071A1, US20220333765A1, US20220228366A1, US20220196906A1, US20220010554A1, US20080043490A1, US20060290253A1, US20060215958A1, US20120321247, US20120250330, US20120099204
Canada	CA2702600, CA2702685, CA2702690
France	FREP0800658
Germany	DEEP0800658
Great Britain	GB2492541, GB2492542, GBEP0800658, GB2492398
Japan	JP03958359
Netherlands	NLEP0800658
Taiwan	FTW360813B
European Patent Organization	EP0843203, EP0843203

Design Patents

United States	USD719282, USD717973, USD669606, USD669608, USD669609, USD669614, USD663056
----------------------	---

The Patent Corporation Treaty

World Intellectual Property Organization	WO2015200268
---	--------------

Trademarks

United States	US6672871, US6397231, US6373493, US6257728, US6190558, US6190559, US6142905, US6114408, US6038234, US6025279, US6060740, US6257729, US5856164, US5734112, US5543304, US5309290, US5309315, US4691124, US4640751
----------------------	---