

NANOSquare Surface

Direct | Standard Lengths



Project Name _____

Fixture Type _____

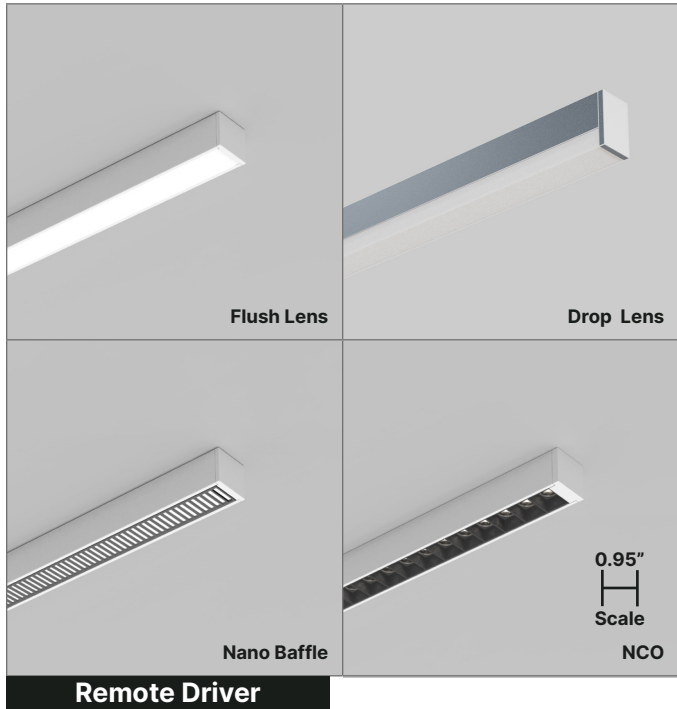

DESCRIPTION

0.95" Compact Linear LED Surface Mount

NANOSquare95 Surface is 0.95" square surface mounted LED linear light fixture, bringing SmartBeam® capabilities to a graphic scale that complements architectural space. NANOSquare95 Surface features a remote driver and "power over cable" technology to remove visual bulk.

FEATURES & BENEFITS

Exceptional Performance

Up to 1,000 lm/ft, 135 lm/W efficacy

Wide Range of LED Selections

Static, Tunable White, and Dim-to-Warm

Designed with Options

Wide choice of SmartOptic® lenses, beam distributions, 80/90/95+ CRI, 2200K to 6500K CCT, and 0-10V, DALI, DMX, and TRIAC dimming

Patented Innovations

Fusion® Optix Inside with unique SmartBeam® capabilities

Proprietary Optical Components

Provides excellent light distribution and high-transmission

Committed to Sustainability

Declare Listed and Red Free List materials

Compliance

UL Listed, Dry and Damp Locations

5-Year Warranty

Standard 5-year warranty, 50,000 hours

LIGHTING CONFIGURATIONS

Direct

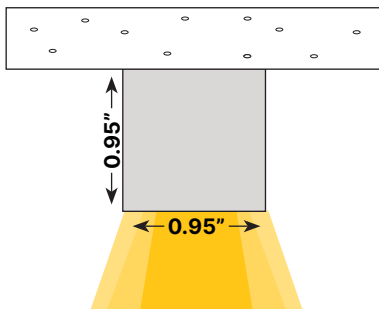

Designed & Built in
BOSTON

FIXTURE ORDERING

Project Name _____

Fixture Type _____

1) FIXTURE DESIGN				
PRODUCT	FIXTURE LENGTH	FINISH	END CAP STYLE	
NSQ95-S 0.95" Compact Linear LED Surface Mount	2 - 2 ft 4 - 4 ft 6 - 6 ft 8 - 8 ft X_ - Specify Ft', In"	Powder Coated PMW - Matte White PMB - Matte Black PMG - Matte Gray PRAL_ - Specify RAL #	E1 - Flat End Cap	
	Custom fixtures are available in 3" increments beyond standard lengths.	Anodized ACL - Clear Anodized ACU_ - Custom Anodized #		
2) LED LIGHT ENGINE				
CRI	CCT	OPTIC (DIRECT ONLY)	DIRECT BEAM PATTERN	DIRECT OUTPUT
80 - Std. 80 CRI 90 - Std. 90 CRI 95 - High-Def. 95 CRI SUN - Full SunLike	27 - 2700K 30 - 3000K 35 - 3500K 40 - 4000K XD - Dim-to-Warm ¹ XT - Tunable ¹ X_ - Specify CCT Specify Dim-to-Warm and Tunable between 2700K-6500K.	OFL - Flush Lens ONBW - Nano Baffle, White ONBB - Nano Baffle, Black	DLAM - Lambertian DBW60 - Batwing 60° DDA70 - Double Asym 70° DA5025 - Asym 50° at 25° Tilt DA4005 - Asym 40° at 5° Tilt DM55 - Medium 55° DN40 - Narrow 40° X_ - Specify Beam ¹	35 - 350 lm/ft 50 - 500 lm/ft 75 - 750 lm/ft 100 - 1,000 lm/ft X_ - Specify lm/ft
		OSDL05 - Square Drop Lens 1/2"	NN - Not Needed DLAM - Lambertian	
	27 - 2700K 30 - 3000K 35 - 3500K 40 - 4000K	OSNCOW - Square NCO, White OSNCOB - Square NCO, Black ORNCOW - Round NCO, White ORNCOB - Round NCO, Black ORNCOG - Round NCO, Graphite	DS45 - Nano Cavity Optics Spot 45° DS35 - Nano Cavity Optics Spot 35° DS25 - Nano Cavity Optics Spot 25°	
3) FIXTURE POWER & CONTROLS				
LINE VOLTAGE (DC)	REMOTE DRIVER (POWER) ²			
UNV - 120/277V 347 - 347V	FDND - Factory Non-Dimming FD00 - Factory 0-10V 0.1% Dim FD01 - Factory 0-10V 1% Dim FD10 - Factory 0-10V 10% Dim FDDA - Factory DALI 0.1% Dim FDDX - Factory DMX Dim FDTR - Factory TRIAC Dim LD01 - Lutron Hi-Lume 1% Dim X_ - Specify Driver	Footnotes: ¹ Contact factory about custom beam options. ² Standard driver box is included		

4) FIXTURE MOUNTING & CONNECTIONS

MOUNTING TYPE	POWER CORD	MOUNTING KIT
<p>SC1 - Surface Mount Clip SM1 - Surface Magnet Mount TC1 - 9/16" Flat T-Bar Mount TC2 - 9/16" Bolt Slot T-Bar Mount TC3 - 15/16" Flat T-Bar Mount</p> <p>TC1, TC2 and TC3 clips directly to grid t-bar.</p>	<p>P48W - 48" White Cord (Ø 1/8") P48B - 48" Black Cord (Ø 1/8") P96W - 96" White Cord (Ø 1/8") P96B - 96" Black Cord (Ø 1/8")</p>	<p>SSMB - Stainless Steel Surface Mounting Bracket</p>

OPTIONAL

EMERGENCY BACKUP	WIRELESS MODULE
<p>EMC - Emergency Circuit EMB - Emergency Battery (10 W — Remote) X_ - Specify Backup</p> <p>Specify requirements at time of order.</p>	<p>WCN - Wireless Communication Node (Connected to LED Driver In-Fixture or In-Driver Box) PIR - Wireless Communication Node + PIR Sensor (Standard Lens for Low Bay < 10') MW - Wireless Communication Node + MW Sensor (Standard for Low Bay < 10') X_ - Other – Specify Embedded Component or Specific Non-Standard Sensor Detection Range</p>

DIMENSIONS & INSTALLATION

Dimensions

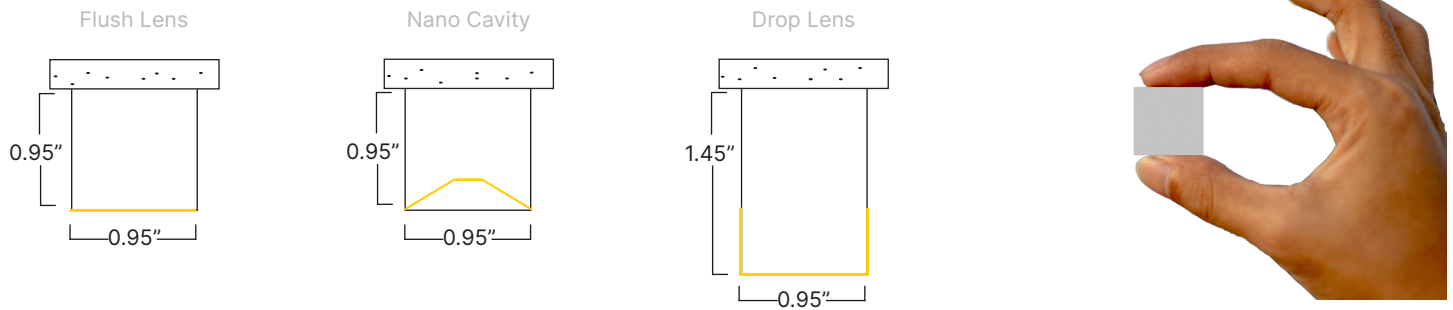

Standard Fixtures

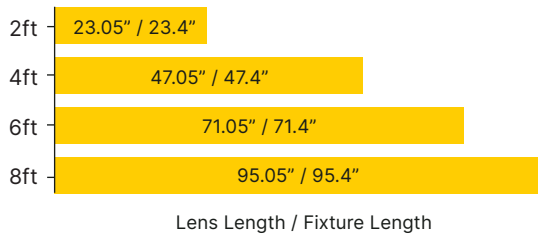

Mounting Type

T-Bar Mount

Installs into a ceiling grid system and mount on to, or replace, typical T-Bar elements. Available with a range of accessories, mounts and inserts that provide easy customization of visual appearance and performance enhancements.

Surface Mount

Installs onto a surface via clip or magnet. Available with a range of accessories, mounts and inserts that provide easy customization of visual appearance and performance enhancements.

Mounting Kit

Surface Mounting Bracket Stainless Steel

Mounting Options

MK1 - Clip Mount

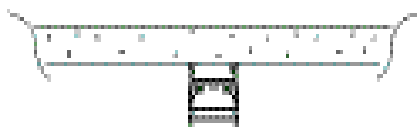

MK2 - Magnet Mount

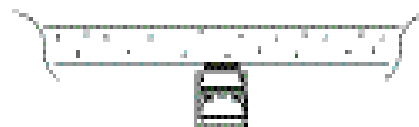

MK3 - Fixed Mount



MK4 - Adjustable Mount



SMARTBEAM® TECHNOLOGY

The Ultimate Control of Lighting Distributions

SmartBeam makes it easy to specify the exact light required for any architectural space. Available in every XICO product; it is now possible to create truly tailored and engaging lighting that transform spaces, improves visual comfort, and saves energy.

To learn more about our SmartBeam Technology, please click or scan the QR Code.



Direct Optics Choices

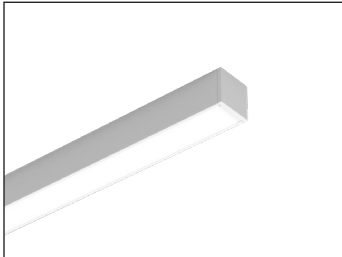

FL - Flush Lens

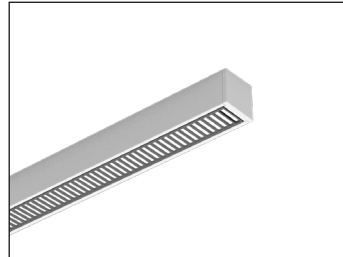

NB - Nano Baffle

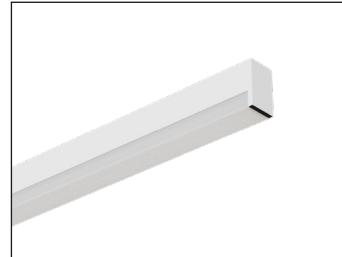

SDL - Square Drop Lens 1/2"



NCO - Nano Cavity Optics

DIRECT OPTICS	BEAM PATTERN									
	DLAM	DBW60	DDA70	DA5025	DA4005	DM55	DN40	DS45	DS35	DS25
Flush Lens	■	■	■	■	■	■	■			
Nano Baffle	■	■	■	■	■	■	■			
Drop Lens 1/2"	■									
NCO								■	■	■

LPW Efficacy Conversion Chart

CODE	CCT SELECTED							
	2200K	2700K	3000K	3500K	4000K	5000K	5700K	6500K
80	-	0.91	0.96	1.00	1.04	1.11	1.11	1.11
90	-	0.91	0.96	1.00	1.04	1.11	1.11	1.11
95	-	0.91	0.96	1.00	1.04	1.11	1.03	1.04
SUN	-	0.90	0.92	1.00	1.01	1.07	1.04	1.05

LPW Performance

LM/W	DIRECT									
	DLAM	DBW60	DDA70	DA5025	DA4005	DM55	DN40	DS45	DS35	DS25
LM/W	111	123	123	130	128	129	116	82	82	82

$$LM/W = \frac{\left(\begin{matrix} \text{DIRECT} \\ \text{LM/FT} \end{matrix} + \begin{matrix} \text{INDIRECT} \\ \text{LM/FT} \end{matrix} \right)}{\left(\begin{matrix} \text{DIRECT} \\ \text{W/FT} \end{matrix} + \begin{matrix} \text{INDIRECT} \\ \text{W/FT} \end{matrix} \right)}$$

DIRECT PHOTOMETRICS

48" Length, 80+/3500K CRI/CCT, 3,000 Lumens

Static White Light

DLAM: Lambertian

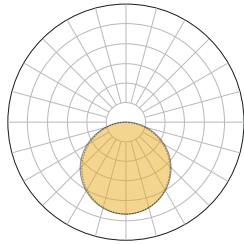

LM/FT	W/FT	LM/W
350	3.2	109.4
500	4.6	108.7
750	6.9	108.7
1000	9.2	108.7

DLAM: Lambertian w/ 1/2" Drop Lens

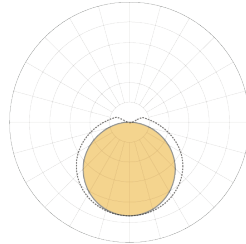

LM/FT	W/FT	LM/W
350	2.5	140
500	3.5	142.9
750	5.3	142.7
1000	7.1	140.8

DBW60: Batwing 60°

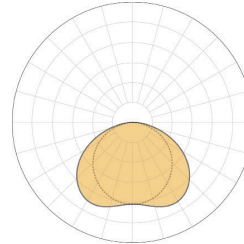

LM/FT	W/FT	LM/W
350	2.8	123
500	4	125
750	6	125
1000	8	125

DDA70: Double Asymmetric 70°

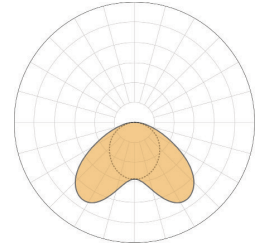

LM/FT	W/FT	LM/W
350	2.8	125
500	4.1	122
750	6.1	123
1000	8.1	123.5

DA5025: Asymmetric 50° at 25° Tilt

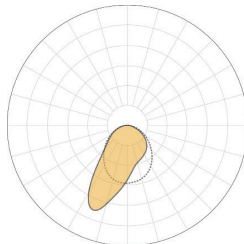

LM/FT	W/FT	LM/W
350	2.8	123
500	4	125
750	6	125
1000	8	125

DA4005: Asymmetric 40° at 5° Tilt

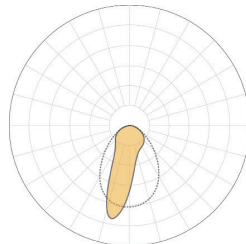

LM/FT	W/FT	LM/W
350	2.8	125
500	3.9	128.2
750	5.9	127.1
1000	7.9	126.6

DM55: Medium 55°

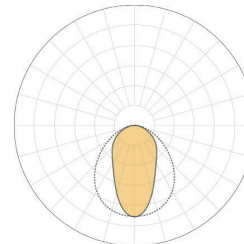

LM/FT	W/FT	LM/W
350	2.8	125
500	3.9	128.2
750	5.9	127.1
1000	7.9	126.6

DN40: Narrow 40°

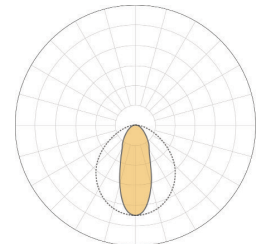

LM/FT	W/FT	LM/W
350	2.8	123
500	4	125
750	6	125
1000	8	125

DS45: Nano Cavity Optic Spot 45°

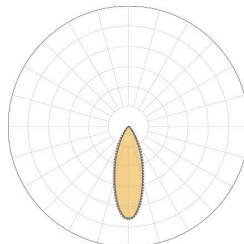

LM/FT	W/FT	LM/W
350	4.2	83.3
500	6	83.3
750	9	83.3
1000	12	83.3

DS35: Nano Cavity Optic Spot 35°

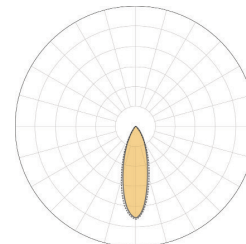

LM/FT	W/FT	LM/W
350	4.2	83.3
500	6	83.3
750	9	83.3
1000	12	83.3



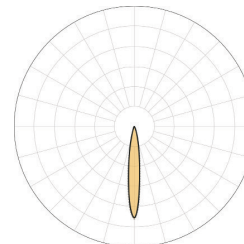

DS25: Nano Cavity Optic Spot 25°



LM/FT	W/FT	LM/W
350	4.2	83.3
500	6	83.3
750	9	83.3
1000	12	83.3

COMPATIBLE OPTIC	
FLUSH LENS	NANO BAFFLE
DROP LENS	NCO

OPTICS CONFIGURATIONS

				
Flush Lens	Square Drop Lens	Nano Baffle	Square NCO	Round NCO
White Flush Lens OFL	White Square Drop Lens OSDLO5	White Nano Baffle ONBW	White Square NCO OSNCOW	White Round NCO ORNCOW
		Black Nano Baffle ONBB	Black Square NCO OSNCOB	Black Round NCO ORNCOB
				Graphite Round NCO ORNCOG

POWER & CONTROLS

Voltage

Fixture Voltage (AC)

120–277 VAC
347 VAC, 50/60 Hz

Power Location

Remote

LED Driver

Factory Selected, 36–39V Constant Current

Drivers

FDND - Factory Non-Dimming
FD00 - Factory 0-10V 0.1% Dim
FD01 - Factory 0-10V 1% Dim
FD10 - Factory 0-10V 10% Dim
FDDA - Factory DALI 0.1% Dim
FDDX - Factory DMX Dim
FDTR - Factory TRIAC Dim
LD01 - Lutron Hi-Lume 1% Dim
X_ - Specify Driver

Emergency Backup (Optional)

EMC - Emergency Circuit
EMB - Emergency Battery
(10 W — Remote)
X_ - Specify Backup

Power

10 W

Illumination Time

90 minutes

IP Rating

Suitable for Dry and Damp Locations,
indoor use only

XBox

Remote Driver Boxes (Optional)

To create a clean and organized power solution for multiple fixture installations see our Xbox Specification Guide. Reach out to a XICO Sales Representative to discuss your projects needs.

Compatible Control Options



