

# MICROBeam Wall

Direct, Indirect, Direct / Indirect | Standard Lengths



Project Name \_\_\_\_\_

Fixture Type \_\_\_\_\_

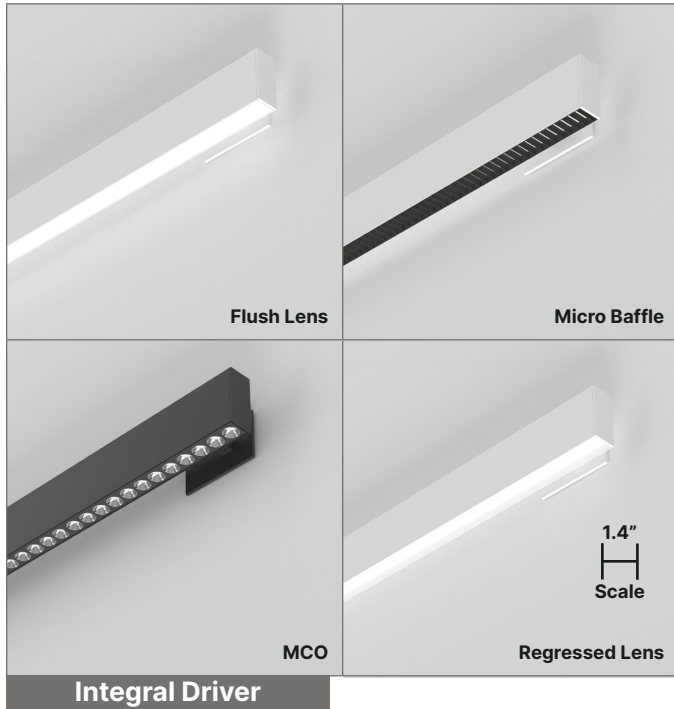

## DESCRIPTION

### 1.4" Low-Profile Linear LED Wall Mount

MICROBeam Wall is a 1.4" linear for surface mounting, typically to a wall ceiling. MICROBeam Wall includes an integral, field serviceable, on-board driver. MICROBeam Wall brings SmartBeam® capabilities up to a powerful 2000 lumens per foot combined direct and indirect. It's small size designed to compliment architectural space. MICROBeam Wall is fully field serviceable and can be supplied in continuous runs and a variety of visually appealing shapes.

## FEATURES & BENEFITS

### Exceptional Performance

Up to 1,000 lm/ft, 150 lm/W efficacy

### Wide Range of LED Selections

Static, Tunable White, and Dim-to-Warm

### Designed with Options

Wide choice of SmartOptic® lenses, beam distributions, 80/90/95+ CRI, 2700K to 6500K CCT, and 0-10V, DALI, DMX, and TRIAC dimming

### Patented Innovations

Fusion® Optix Inside with unique SmartBeam® capabilities

### Proprietary Optical Components

Provides excellent light distribution and high-transmission

### Committed to Sustainability

Declare Listed and Red Free List materials

### Compliance

UL Listed, Dry and Damp Locations

### 5-Year Warranty

Standard 5-year warranty, 50,000 hours

## LIGHTING CONFIGURATIONS

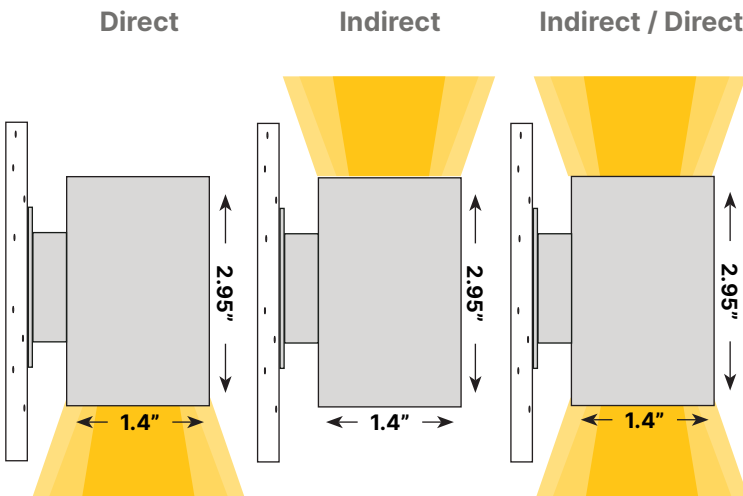

Designed & Built in  
**BOSTON**

## FIXTURE ORDERING

Project Name \_\_\_\_\_

1) FIXTURE DESIGN				
PRODUCT	FIXTURE LENGTH	FINISH	END CAP STYLE	
<b>MBE140-W</b> 1.4" Low-Profile Linear LED Pendant Mount	2 - 2 ft 4 - 4 ft 6 - 6 ft 8 - 8 ft X_ - Specify Ft', In"	<b>Powder Coated</b> <b>PMW</b> - Matte White <b>PMB</b> - Matte Black <b>PMG</b> - Matte Gray <b>PRAL_</b> - Specify RAL #  <b>Anodized</b> <b>ACL</b> - Clear Anodized <b>ACU_</b> - Custom Anodized #	<b>E1</b> - Flat End Cap	
	Custom fixtures are available in 3" increments beyond standard lengths.			
2) LED LIGHT ENGINE				
CRI	CCT	OPTIC (DIRECT ONLY)	DIRECT BEAM PATTERN	DIRECT OUTPUT
<b>80</b> - Std. 80 CRI <b>90</b> - Std. 90 CRI <b>95</b> - High-Def. 95 CRI <b>SUN</b> - Full SunLike	27 - 2700K 30 - 3000K 35 - 3500K 40 - 4000K XD - Dim-to-Warm XT - Tunable X_ - Specify CCT  Specify Dim-to-Warm and Tunable between 2700K-6500K.	<b>OFL</b> - Flush Lens <b>ORL</b> - Regressed Lens <b>OCRL</b> - Continuous Regressed Lens <sup>1</sup> <b>OMBW</b> - Micro Baffle, White <b>OMBB</b> - Micro Baffle, Black	<b>NN</b> - Not Needed <b>DLAM</b> - Lambertian <b>DBW60</b> - Batwing 60° <b>DDA70</b> - Double Asym 70° <b>DA4015</b> - Asym 40° at 15° Tilt <b>DA3010</b> - Asym 30° at 10° Tilt <b>DM70</b> - Medium 70° <b>DN40</b> - Narrow 40° X_ - Specify Beam <sup>2</sup>	<b>NN</b> - Not Needed <b>35</b> - 350 lm/ft <b>50</b> - 500 lm/ft <b>75</b> - 750 lm/ft <b>100</b> - 1,000 lm/ft X_ - Specify lm/ft
	27 - 2700K 30 - 3000K 35 - 3500K 40 - 4000K	<b>ORMCOWB</b> - Round MCO, White w/ Black Cover <b>ORMCOBB</b> - Round MCO, Black w/ Black Cover <b>ORMCOGB</b> - Round MCO, Graphite w/ Black Cover <b>ORMCOCHB</b> - Round MCO, Chrome w/ Black Cover <b>ORMCOCB</b> - Round MCO, Copper w/ Black Cover	<b>DS45</b> - Micro Cavity Optics Spot 45° <b>DS35</b> - Micro Cavity Optics Spot 35° <b>DS25</b> - Micro Cavity Optics Spot 25°	
INDIRECT BEAM PATTERN	INDIRECT OUTPUT	CIRCUIT		
<b>NN</b> - Not Needed <b>ILAM</b> - Lambertian <b>IBW120</b> - Batwing 120° <b>IFT150</b> - FlatTop 150° <b>IA6040</b> - Asym 60° at 40° Tilt <b>IA4560</b> - Asym 45° at 60° Tilt X_ - Specify Beam <sup>2</sup>	<b>NN</b> - Not Needed <b>35</b> - 350 lm/ft <b>50</b> - 500 lm/ft <b>75</b> - 750 lm/ft <b>100</b> - 1,000 lm/ft X_ - Specify lm/ft	<b>1CH</b> - 1 Circuit (Standard) <b>2CH</b> - Bi-Directional 2 Circuit (Optional)		
3) FIXTURE POWER & CONTROLS				
LINE VOLTAGE (DC)	INTEGRAL DRIVER (POWER) <sup>3</sup>			
<b>UNV</b> - 120/277V <b>347</b> - 347V	<b>FDND</b> - Factory Non-Dimming <b>FD00</b> - Factory 0-10V 0.1% Dim <b>FD01</b> - Factory 0-10V 1% Dim <b>FD10</b> - Factory 0-10V 10% Dim <b>FDDA</b> - Factory DALI 0.1% Dim <b>FDDX</b> - Factory DMX Dim <b>FDTR</b> - Factory TRIAC Dim <b>LD01</b> - Lutron Hi-Lume 1% Dim X_ - Specify Driver			
	Footnotes: <sup>1</sup> Continuous Regressed Lens ships on a roll for seamless lens installation. <sup>2</sup> Contact factory about custom beam options. <sup>3</sup> Standard driver box is included			

4) FIXTURE MOUNTING & CONNECTIONS	
MOUNTING TYPE	MOUNTING KIT
<b>WM</b> - Wall Mount	<b>WM2W</b> - 2.8" White Stainless Steel Wall Mounting Plate <b>WM2B</b> - 2.8" Black Stainless Steel Wall Mounting Plate

OPTIONAL	
EMERGENCY BACKUP	WIRELESS MODULE
<p><b>EMC</b> - Emergency Circuit <b>EMB</b> - Emergency Battery (10 W — Remote) <b>X_</b> - Specify Backup</p> <p>Specify requirements at time of order.</p>	<p><b>WCN</b> - Wireless Communication Node (Connected to LED Driver In-Fixture or In-Driver Box) <b>PIR</b> - Wireless Communication Node + PIR Sensor (Standard Lens for Low Bay &lt; 10') <b>MW</b> - Wireless Communication Node + MW Sensor (Standard for Low Bay &lt; 10') <b>X_</b> - Other – Specify Embedded Component or Specific Non-Standard Sensor Detection Range</p>

## DIMENSIONS & INSTALLATION

### Dimensions

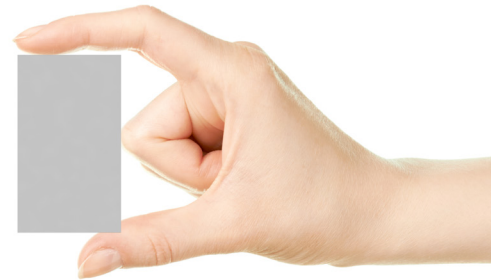
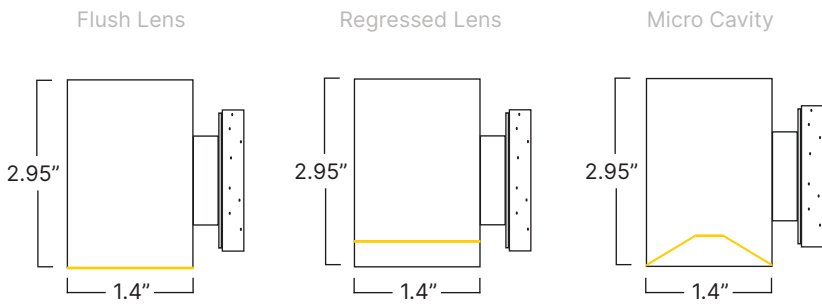

### Standard Fixtures

2ft	23.05" / 23.4"
4ft	47.05" / 47.4"
6ft	71.05" / 71.4"
8ft	95.05" / 95.4"

Lens Length / Fixture Length

### Mounting Type

#### Wall Mount

Installs onto a wall. Available with a range of accessories, mounts and inserts that provide easy customization of visual appearance and performance enhancements.

### Mounting Kit

#### Wall Mounting Kit

2.8" Stainless Steel Wall Mounting Plate, White and Black.

### Mounting Option

#### WM - Wall Mount

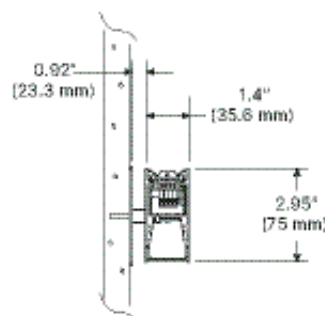

## SMARTBEAM® TECHNOLOGY

### The Ultimate Control of Lighting Distributions

SmartBeam makes it easy to specify the exact light required for any architectural space. Available in every XICO product; it is now possible to create truly tailored and engaging lighting that transform spaces, improves visual comfort, and saves energy.

To learn more about our SmartBeam Technology, please click or scan the QR Code.



### Direct Optics Choices

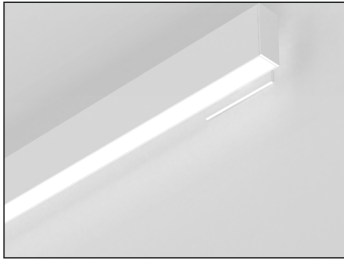

FL - Flush Lens

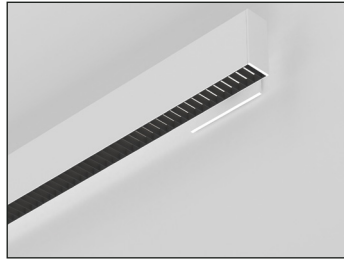

MB - Micro Baffle

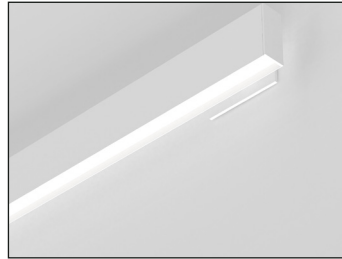

RL - Regressed Lens

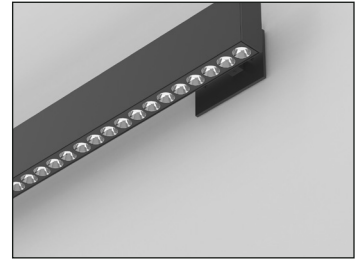

MCO - Micro Cavity Optics

DIRECT OPTICS	BEAM PATTERN									
	DLAM	DBW60	DDA70	DA4015	DA3010	DM70	DN40	DS45	DS35	DS25
Flush Lens	■	■	■	■	■	■	■			
Regressed Lens	■	■	■	■	■	■	■			
Micro Baffle	■	■	■	■	■	■	■			
MCO								■	■	■

### LPW Efficacy Conversion Chart

CODE	CCT SELECTED							
	2200K	2700K	3000K	3500K	4000K	5000K	5700K	6500K
80	-	0.91	0.96	1.00	1.04	1.11	1.11	1.11
90	-	0.91	0.96	1.00	1.04	1.11	1.11	1.11
95	-	0.91	0.96	1.00	1.04	1.11	1.03	1.04
SUN	-	0.90	0.92	1.00	1.01	1.07	1.04	1.05

### LPW Performance

	DIRECT									
	DLAM	DBW60	DDA70	DA3015	DA3010	DM70	DN40	DS45	DS35	DS25
LM/W	83	141	123	131	130	149	151	82	82	82

	INDIRECT				
	ILAM	IBW120	IFT150	IA6040	IA4560
LM/W	150	158	150	143	143

$$LM/W = \frac{\left( \begin{matrix} \text{DIRECT} \\ \text{LM/FT} \end{matrix} + \begin{matrix} \text{INDIRECT} \\ \text{LM/FT} \end{matrix} \right)}{\left( \begin{matrix} \text{DIRECT} \\ \text{W/FT} \end{matrix} + \begin{matrix} \text{INDIRECT} \\ \text{W/FT} \end{matrix} \right)}$$

## DIRECT PHOTOMETRICS

48" Length, 80+/3500K CRI/CCT, 3,000 Lumens

Static White Light

**DLAM:** Lambertian

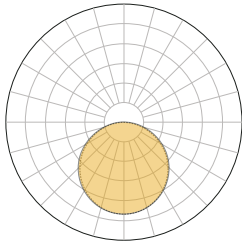

LM/FT	W/FT	LM/W
350	4.2	83.3
500	6	83.3
750	9	83
1000	12	83.3

**DBW60:** Batwing 60°

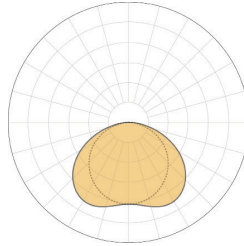

LM/FT	W/FT	LM/W
350	2.5	140
500	3.5	142.9
750	5.3	141
1000	7.1	140.1

**DDA70:** Double Asymmetric 70°

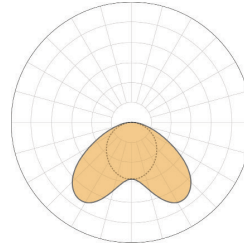

LM/FT	W/FT	LM/W
350	2.8	125
500	4.1	122
750	6.1	123
1000	8.1	123.5

**DA4015:** Asymmetric 40° at 15° Tilt

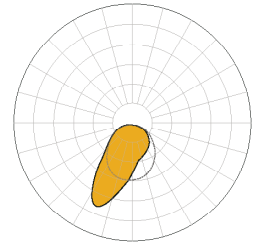

LM/FT	W/FT	LM/W
350	2.7	129.6
500	3.8	131.6
750	5.7	131
1000	7.6	131.6

**DA3010:** Asymmetric 30° at 10° Tilt

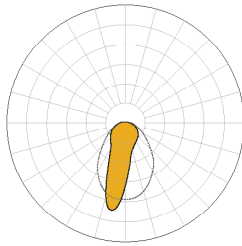

LM/FT	W/FT	LM/W
350	2.8	125
500	3.9	128.2
750	5.8	130
1000	7.7	129.9

**DM70:** Medium 70°

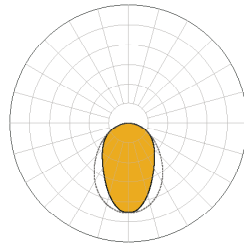

LM/FT	W/FT	LM/W
350	2.3	152
500	3.3	151.5
750	5	149
1000	6.7	149.3

**DN40:** Narrow 40°

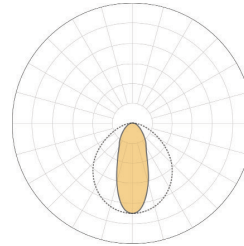

LM/FT	W/FT	LM/W
350	2.3	152
500	3.3	151.5
750	5	151
1000	6.7	149.3

**DS45:** Micro Cavity Optic Spot 45°

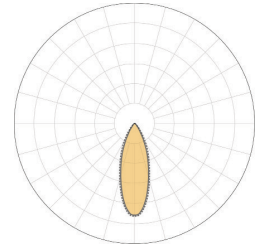

LM/FT	W/FT	LM/W
350	4.2	83.3
500	6.1	82
750	9.1	82
1000	12.1	82.6

**DS35:** Micro Cavity Optic Spot 35°

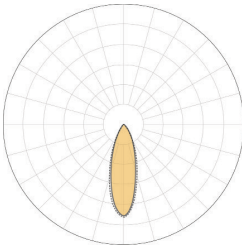

LM/FT	W/FT	LM/W
350	4.2	83.3
500	6.1	82
750	9.1	82
1000	12.1	82.6

**DS25:** Micro Cavity Optic Spot 25°

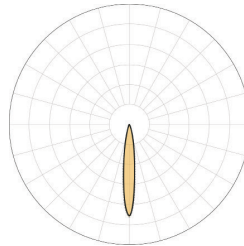

LM/FT	W/FT	LM/W
350	4.2	83.3
500	6.1	82
750	9.1	82
1000	12.1	82.6

COMPATIBLE OPTIC			
FLUSH LENS	REGRESSED LENS	MICRO BAFFLE	MCO
■	■	■	■

## INDIRECT PHOTOMETRICS

48" Length, 80+/3500K CRI/CCT, 4,000 Lumens

Static White Light

**ILAM:** Lambertian

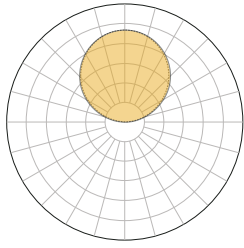

LM/FT	W/FT	LM/W
350	2.3	152
500	3.3	151.5
750	5	<b>151</b>
1000	6.7	149.3

**IBW120:** Batwing 120°

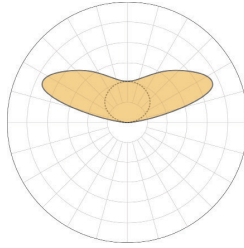

LM/FT	W/FT	LM/W
350	2.2	159.1
500	3.1	161.3
750	4.7	158
1000	6.3	158.7

**IFT150:** FlatTop 150°

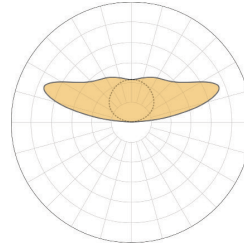

LM/FT	W/FT	LM/W
350	2.3	152
500	3.3	151.5
750	5	<b>151</b>
1000	6.7	149.3

**IA6040:** Asymmetric 60° at 40° Tilt

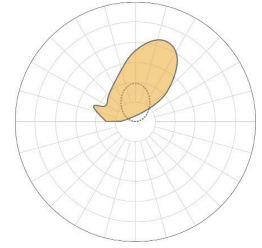



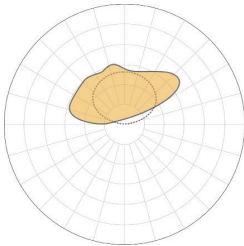

LM/FT	W/FT	LM/W
350	2.4	145.8
500	3.5	142.9
750	5.2	143
1000	6.9	144.9

**IA4560:** Asymmetric 45° at 60° Tilt







LM/FT	W/FT	LM/W
350	2.4	145.8
500	3.5	142.9
750	5.2	143
1000	6.9	144.9

## OPTICS CONFIGURATIONS

				
<b>Flush Lens</b>	<b>Regressed Lens</b>	<b>Continuous Regressed Lens</b>	<b>Micro Baffle</b>	<b>Round MCO</b>
White Flush Lens <b>OFL</b>	White Regressed Lens <b>ORL</b>	White Regressed Lens <b>OCRL</b>	White Micro Baffle <b>OMBW</b>	<b>ORMCOWB</b> White w/Black Cover
			Black Micro Baffle <b>OMBB</b>	<b>ORMCOBB</b> Black w/Black Cover
				<b>ORMCOGB</b> Graphite w/Black Cover
				<b>ORMCOCHB</b> Chrome w/Black Cover
				<b>ORMCOCB</b> Copper w/Black Cover

## MICRO CAVITY OPTICS CHOICES

				
<b>ORMCOWB</b> Round MCO, White Black Cover	<b>ORMCOBB</b> Round MCO, Black Black Cover	<b>ORMCOGB</b> Round MCO, Graphite Black Cover	<b>ORMCOCHB</b> Round MCO, Chrome Black Cover	<b>ORMCOCB</b> Round MCO, Copper Black Cover

## LED OPTIONS

80: Standard 80+ CRI

90: Standard 90+ CRI

95: High-Definition 95+ CRI

SUN: Full Spectrum "SunLike"

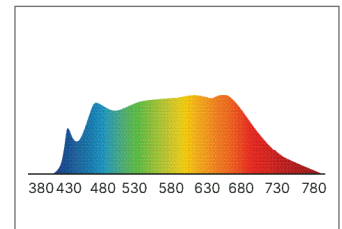
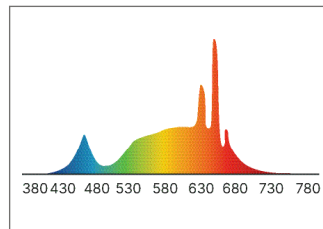
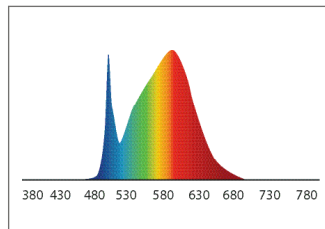
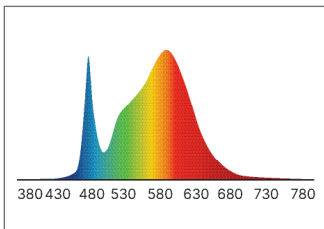

CODE	DESCRIPTION	TYPICAL LED DATA							
		CCT	CRI	CRI R9	TM30 Rf	TM30 Rg	CQS	M/P Ratio	LPW
80	Standard 80 CRI	3500K	82.5	7.8	84	96.7	82.5	0.51	190
90	Standard 90 CRI	3500K	91	54.3	89.3	98.9	89.2	0.55	175
95	High Definition 95 CRI	3500K	97.1	95	-	-	-	0.70	163
SUN	Full Spectrum SunLike®	3500K	95	85	-	-	-	-	130

## POWER & CONTROLS

### Voltage

#### Fixture Voltage (AC)

120–277 VAC  
347 VAC, 50/60 Hz

#### Power Location

Integral

#### LED Driver

Factory Selected, 36–39V Constant Current

### Drivers

**FDND** - Factory Non-Dimming  
**FD00** - Factory 0-10V 0.1% Dim  
**FD01** - Factory 0-10V 1% Dim  
**FD10** - Factory 0-10V 10% Dim  
**FDDA** - Factory DALI 0.1% Dim  
**FDDX** - Factory DMX Dim  
**FDTR** - Factory TRIAC Dim  
**LD01** - Lutron Hi-Lume 1% Dim  
**X\_** - Specify Driver

### Emergency Backup (Optional)

**EMC** - Emergency Circuit  
**EMB** - Emergency Battery  
(10 W — Remote)  
**X\_** - Specify Backup

#### Power

10 W

#### Illumination Time

90 minutes

#### IP Rating

Suitable for Dry and Damp Locations,  
indoor use only

### XBox

#### Remote Driver Boxes (Optional)

To create a clean and organized power solution for multiple fixture installations see our Xbox Specification Guide. Reach out to a XICO Sales Representative to discuss your projects needs.

### Compatible Control Options



