

MICROBeam Surface

Indirect | Standard Lengths



Project Name _____

Fixture Type _____

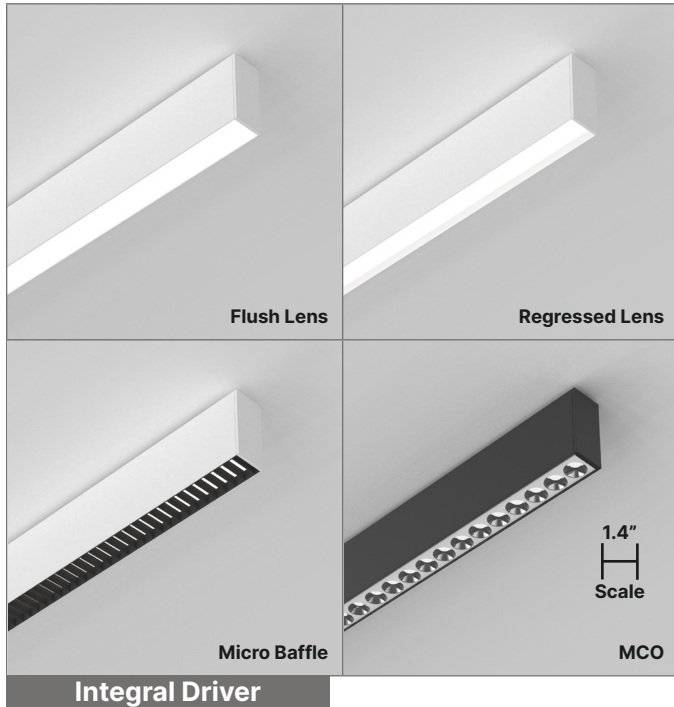

DESCRIPTION

1.4" Low-Profile Linear LED Surface Mount

MICROBeam Surface is a 1.4" linear for surface mounting, typically to a drywall ceiling. MICROBeam Surface includes an integral, field serviceable, on-board driver. MICROBeam Surface brings SmartBeam® capabilities up to a powerful 2000 lumens per foot combined direct and indirect. It's small size designed to compliment architectural space. MICROBeam Surface is fully field serviceable and can be supplied in continuous runs and a variety of visually appealing shapes.

FEATURES & BENEFITS

Exceptional Performance

Up to 1,000 lm/ft, 150 lm/W efficacy

Wide Range of LED Selections

Static, Tunable White, and Dim-to-Warm

Designed with Options

Wide choice of SmartOptic® lenses, beam distributions, 80/90/95+ CRI, 2700K to 6500K CCT, and 0-10V, DALI, DMX, and TRIAC dimming

Patented Innovations

Fusion® Optix Inside with unique SmartBeam® capabilities

Proprietary Optical Components

Provides excellent light distribution and high-transmission

Committed to Sustainability

Declare Listed and Red Free List materials

Compliance

UL Listed, Dry and Damp Locations

5-Year Warranty

Standard 5-year warranty, 50,000 hours

LIGHTING CONFIGURATIONS

Direct

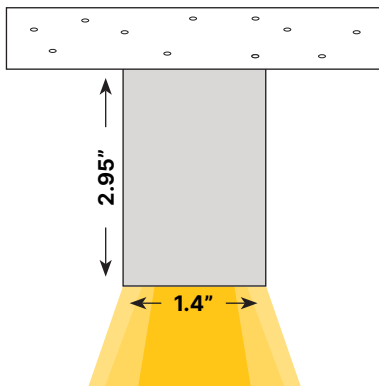

FIXTURE ORDERING

Project Name _____

Fixture Type _____

1) FIXTURE DESIGN

PRODUCT	FIXTURE LENGTH	FINISH	END CAP STYLE
MBE140-S 1.4" Low-Profile Linear LED Surface Mount	2 - 2 ft 4 - 4 ft 6 - 6 ft 8 - 8 ft X_ - Specify Ft', In"	Powder Coated PMW - Matte White PMB - Matte Black PMG - Matte Gray PRAL_ - Specify RAL # Anodized ACL - Clear Anodized ACU_ - Custom Anodized #	E1 - Flat End Cap
	Custom fixtures are available in 3" increments beyond standard lengths.		

2) LED LIGHT ENGINE

CRI	CCT	OPTIC (DIRECT ONLY)	DIRECT BEAM PATTERN	DIRECT OUTPUT
80 - Std. 80 CRI 90 - Std. 90 CRI 95 - High-Def. 95 CRI SUN - Full SunLike	27 - 2700K 30 - 3000K 35 - 3500K 40 - 4000K XD - Dim-to-Warm XT - Tunable X_ - Specify CCT Specify Dim-to-Warm and Tunable between 2700K-6500K.	OFL - Flush Lens ORL - Regressed Lens OCRL - Continuous Regressed Lens ¹ OMBW - Micro Baffle, White OMBB - Micro Baffle, Black	NN - Not Needed DLAM - Lambertian DBW60 - Batwing 60° DDA70 - Double Asym 70° DA4015 - Asym 40° at 15° Tilt DA3010 - Asym 30° at 10° Tilt DM70 - Medium 70° DN40 - Narrow 40° X_ - Specify Beam ²	NN - Not Needed 35 - 350 lm/ft 50 - 500 lm/ft 75 - 750 lm/ft 100 - 1,000 lm/ft X_ - Specify lm/ft
	27 - 2700K 30 - 3000K 35 - 3500K 40 - 4000K	ORMCOWB - Round MCO, White w/ Black Cover ORMCOBB - Round MCO, Black w/ Black Cover ORMCOGB - Round MCO, Graphite w/ Black Cover ORMCOCHB - Round MCO, Chrome w/ Black Cover ORMCOCB - Round MCO, Copper w/ Black Cover	DS45 - Micro Cavity Optics Spot 45° DS35 - Micro Cavity Optics Spot 35° DS25 - Micro Cavity Optics Spot 25°	

3) FIXTURE POWER & CONTROLS

LINE VOLTAGE (DC)	INTEGRAL DRIVER (POWER) ³	
UNV - 120/277V 347 - 347V	FDND - Factory Non-Dimming FD00 - Factory 0-10V 0.1% Dim FD01 - Factory 0-10V 1% Dim FD10 - Factory 0-10V 10% Dim FDDA - Factory DALI 0.1% Dim FDDX - Factory DMX Dim FDTR - Factory TRIAC Dim LD01 - Lutron Hi-Lume 1% Dim X_ - Specify Driver	Footnotes: ¹ Continuous Regressed Lens ships on a roll for seamless lens installation. ² Contact factory about custom beam options. ³ Standard driver box is included

4) FIXTURE MOUNTING & CONNECTIONS

MOUNTING TYPE	POWER CORD	MOUNTING KIT
DJ - Drywall/J-Box Mount/Hard Ceiling Surface TC1 - 9/16" Flat T-Bar Mount TC2 - 9/16" Bolt Slot T-Bar Mount TC3 - 15/16" Flat T-Bar Mount TC1, TC2 and TC3 clips directly to grid t-bar.	P24W - 24" White Cable Kit P24B - 24" Black Cable Kit	SSMB - Stainless Steel Surface Mounting Bracket

OPTIONAL	
EMERGENCY BACKUP	WIRELESS MODULE
<p>EMC - Emergency Circuit EMB - Emergency Battery (10 W — Remote) X_ - Specify Backup</p> <p>Specify requirements at time of order.</p>	<p>WCN - Wireless Communication Node (Connected to LED Driver In-Fixture or In-Driver Box) PIR - Wireless Communication Node + PIR Sensor (Standard Lens for Low Bay < 10') MW - Wireless Communication Node + MW Sensor (Standard for Low Bay < 10') X_ - Other – Specify Embedded Component or Specific Non-Standard Sensor Detection Range</p>

DIMENSIONS & INSTALLATION

Dimensions

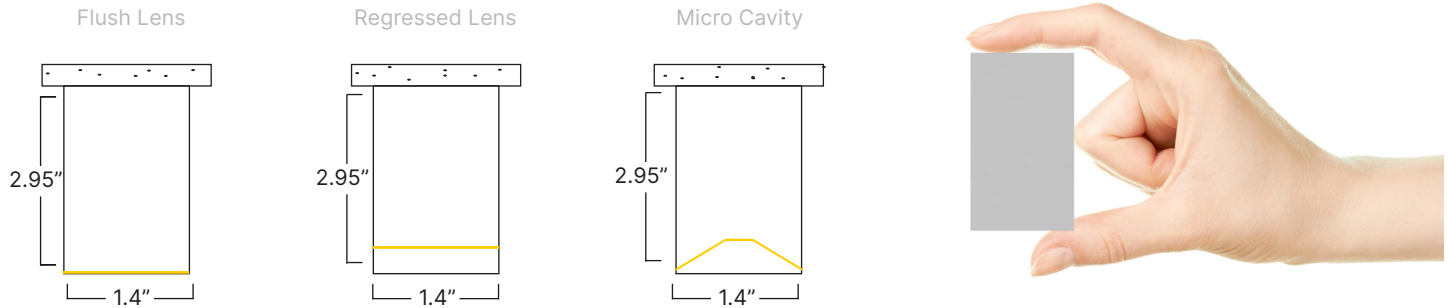

Standard Fixtures

2ft	23.05" / 23.4"
4ft	47.05" / 47.4"
6ft	71.05" / 71.4"
8ft	95.05" / 95.4"

Lens Length / Fixture Length

Mounting Type

T-Bar Mount

Installs into a ceiling grid system and mount on to, or replace, typical T-Bar elements.

Drywall/J-Box Mount

Installs onto a surface via a junction box.

Mounting Options

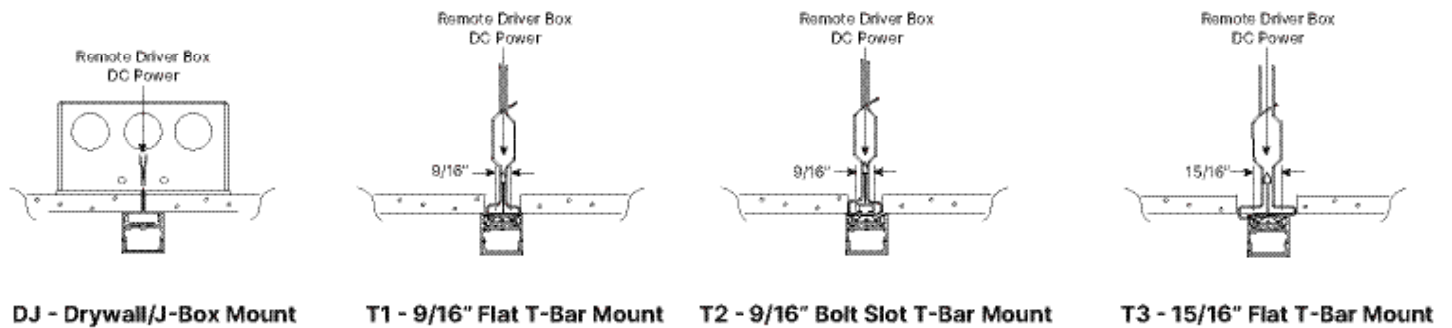

SMARTBEAM® TECHNOLOGY

The Ultimate Control of Lighting Distributions

SmartBeam makes it easy to specify the exact light required for any architectural space. Available in every XICO product; it is now possible to create truly tailored and engaging lighting that transform spaces, improves visual comfort, and saves energy.

To learn more about our SmartBeam Technology, please click or scan the QR Code.



Direct Optics Choices

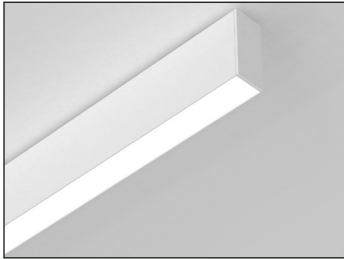

FL - Flush Lens

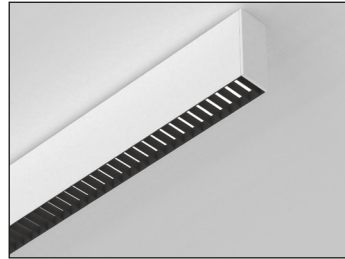

MB - Micro Baffle

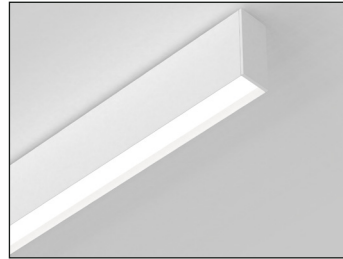

RL - Regressed Lens

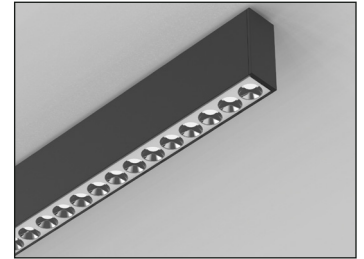

MCO - Micro Cavity Optics

DIRECT OPTICS	BEAM PATTERN									
	DLAM	DBW60	DDA70	DA3015	DA4010	DM70	DN40	DS45	DS35	DS25
Flush Lens	■	■	■	■	■	■	■			
Regressed Lens	■	■	■	■	■	■	■			
Micro Baffle	■	■	■	■	■	■	■			
MCO								■	■	■

LPW Efficacy Conversion Chart

CODE	CCT SELECTED							
	2200K	2700K	3000K	3500K	4000K	5000K	5700K	6500K
80	-	0.91	0.96	1.00	1.04	1.11	1.11	1.11
90	-	0.91	0.96	1.00	1.04	1.11	1.11	1.11
95	-	0.91	0.96	1.00	1.04	1.11	1.03	1.04
SUN	-	0.90	0.92	1.00	1.01	1.07	1.04	1.05

LPW Performance

	DIRECT									
	DLAM	DBW60	DDA70	DA3015	DA3010	DM70	DN40	DS45	DS35	DS25
LM/W	83	141	123	131	130	149	151	82	82	82

$$LM/W = \frac{\left(\begin{matrix} \text{DIRECT} \\ \text{LM/FT} \end{matrix} + \begin{matrix} \text{INDIRECT} \\ \text{LM/FT} \end{matrix} \right)}{\left(\begin{matrix} \text{DIRECT} \\ \text{W/FT} \end{matrix} + \begin{matrix} \text{INDIRECT} \\ \text{W/FT} \end{matrix} \right)}$$

DIRECT PHOTOMETRICS

48" Length, 80+/3500K CRI/CCT, 3,000 Lumens

Static White Light

DLAM: Lambertian

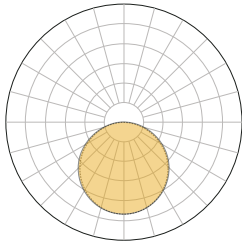

LM/FT	W/FT	LM/W
350	4.2	83.3
500	6	83.3
750	9	83
1000	12	83.3

DBW60: Batwing 60°

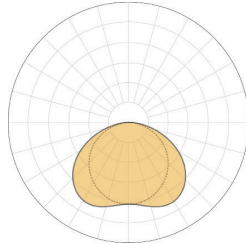

LM/FT	W/FT	LM/W
350	2.5	140
500	3.5	142.9
750	5.3	141
1000	7.1	140.1

DDA70: Double Asymmetric 70°

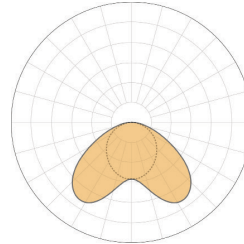

LM/FT	W/FT	LM/W
350	2.8	125
500	4.1	122
750	6.1	123
1000	8.1	123.5

DA4015: Asymmetric 40° at 15° Tilt

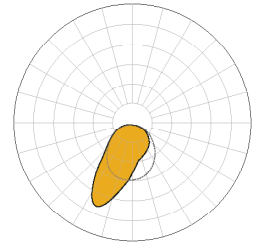

LM/FT	W/FT	LM/W
350	2.7	129.6
500	3.8	131.6
750	5.7	131
1000	7.6	131.6

DA3010: Asymmetric 30° at 10° Tilt

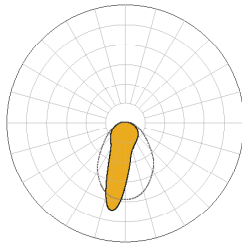

LM/FT	W/FT	LM/W
350	2.8	125
500	3.9	128.2
750	5.8	130
1000	7.7	129.9

DM70: Medium 70°

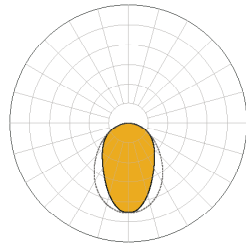

LM/FT	W/FT	LM/W
350	2.3	152
500	3.3	151.5
750	5	149
1000	6.7	149.3

DN40: Narrow 40°

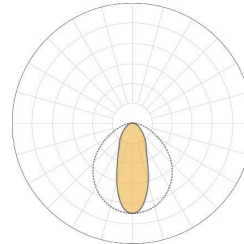

LM/FT	W/FT	LM/W
350	2.3	152
500	3.3	151.5
750	5	151
1000	6.7	149.3

DS45: Micro Cavity Optic Spot 45°

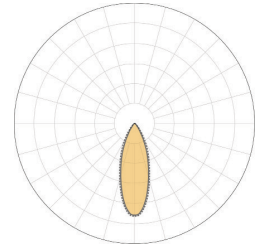

LM/FT	W/FT	LM/W
350	4.2	83.3
500	6.1	82
750	9.1	82
1000	12.1	82.6

DS35: Micro Cavity Optic Spot 35°

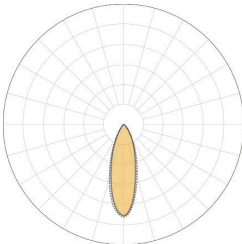

LM/FT	W/FT	LM/W
350	4.2	83.3
500	6.1	82
750	9.1	82
1000	12.1	82.6



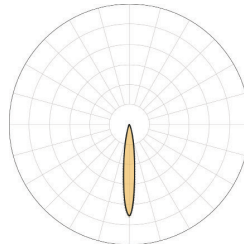

DS25: Micro Cavity Optic Spot 25°



LM/FT	W/FT	LM/W
350	4.2	83.3
500	6.1	82
750	9.1	82
1000	12.1	82.6

COMPATIBLE OPTIC			
FLUSH LENS	REGRESSED LENS	MICRO BAFFLE	MCO

OPTICS CONFIGURATIONS

				
Flush Lens	Regressed Lens	Continuous Regressed Lens	Micro Baffle	Round MCO
White Flush Lens OFL	White Regressed Lens ORL	White Regressed Lens OCRL	White Micro Baffle OMBW	ORMCOWB White w/Black Cover
			Black Micro Baffle OMBB	ORMCOBB Black w/Black Cover
				ORMCOGB Graphite w/Black Cover
				ORMCOCHB Chrome w/Black Cover
				ORMCOCB Copper w/Black Cover

MICRO CAVITY OPTICS CHOICES

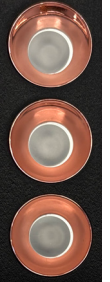
				
ORMCOWB Round MCO, White Black Cover	ORMCOBB Round MCO, Black Black Cover	ORMCOGB Round MCO, Graphite Black Cover	ORMCOCHB Round MCO, Chrome Black Cover	ORMCOCB Round MCO, Copper Black Cover

LED OPTIONS

80: Standard 80+ CRI

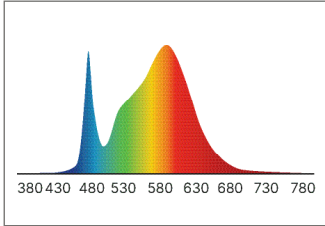

90: Standard 90+ CRI

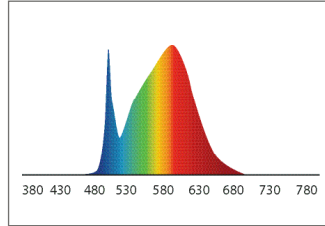

95: High-Definition 95+CRI

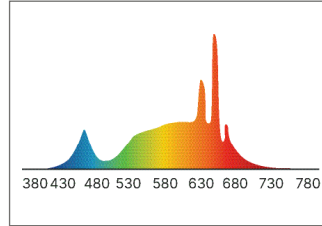

SUN: Full Spectrum "SunLike"

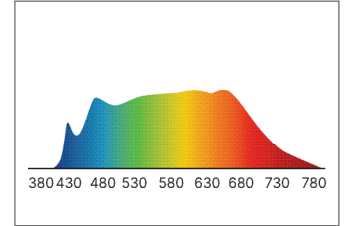

CODE	DESCRIPTION	TYPICAL LED DATA							
		CCT	CRI	CRI R9	TM30 Rf	TM30 Rg	CQS	M/P Ratio	LPW
80	Standard 80 CRI	3500K	82.5	7.8	84	96.7	82.5	0.51	190
90	Standard 90 CRI	3500K	91	54.3	89.3	98.9	89.2	0.55	175
95	High Definition 95 CRI	3500K	97.1	95	-	-	-	0.70	163
SUN	Full Spectrum SunLike®	3500K	95	85	-	-	-	-	130

POWER & CONTROLS

Voltage

Fixture Voltage (AC)

120–277 VAC

347 VAC, 50/60 Hz

Power Location

Integral

LED Driver

Factory Selected, 36–39V Constant Current

Drivers

FDND - Factory Non-Dimming

FD00 - Factory 0-10V 0.1% Dim

FD01 - Factory 0-10V 1% Dim

FD10 - Factory 0-10V 10% Dim

FDDA - Factory DALI 0.1% Dim

FDDX - Factory DMX Dim

FDTR - Factory TRIAC Dim

LD01 - Lutron Hi-Lume 1% Dim

X_ - Specify Driver

Emergency Backup (Optional)

EMC - Emergency Circuit

EMB - Emergency Battery

(10 W — Remote)

X_ - Specify Backup

Power

10 W

Illumination Time

90 minutes

IP Rating

Suitable for Dry and Damp Locations,
indoor use only

XBox

Remote Driver Boxes (Optional)

To create a clean and organized power solution for multiple fixture installations see our XBox Specification Guide. Reach out to a XICO Sales Representative to discuss your projects needs.

Compatible Control Options



