

EDGESlim140

Direct | Standard Lengths



Project Name _____

Fixture Type _____

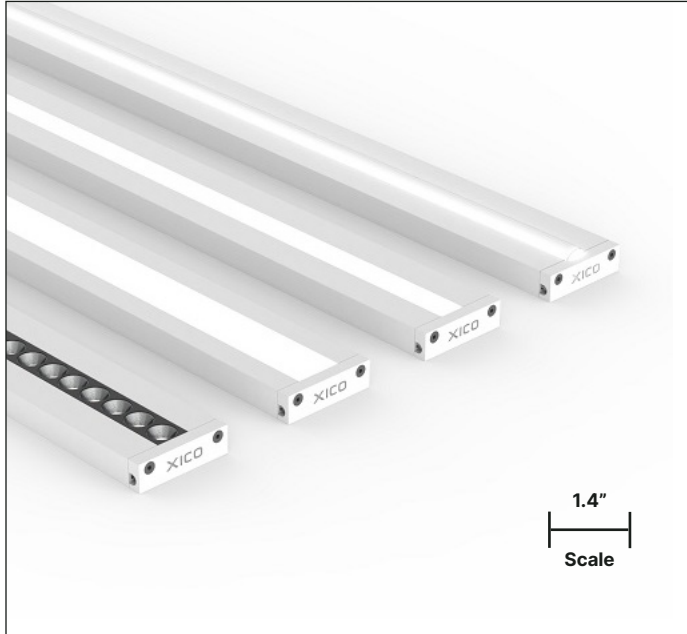

DESCRIPTION

0.5" x 1.4" Low-Profile Flat LED Linear

The MICROFlat140 surface-mounted fixture from XICO is an innovative ultra-slim and compact LED linear product providing best-in-class efficiency and beam control options. The MICROFlat140 is designed to be specification-grade with high lumen per foot, high CRI, and circadian options. MICROFlat140 is powered by a high performance LED light engine with fully customizable choices for lumen output, CCT, and CRI. Based upon unique micro-optical technology; a key feature of the MICROFlat140 is that it delivers a wide range of beam distributions while achieving high efficacy, energy-saving performance.

FEATURES & BENEFITS

Exceptional Performance

Up to 1,000 lm/ft, 150 lm/W efficacy

Wide Range of LED Selections

Static, Tunable White, and Dim-to-Warm

Designed with Options

Wide choice of SmartOptic® lenses, beam distributions, 80/90/95+ CRI, 2700K to 6500K CCT, and 0-10V, DALI, DMX, and TRIAC dimming

Patented Innovations

Fusion® Optix Inside with unique SmartBeam® capabilities

Proprietary Optical Components

Provides excellent light distribution and high-transmission

Committed to Sustainability

Declare Listed and Red Free List materials

Compliance

UL Listed, Dry and Damp Locations

5-Year Warranty

Standard 5-year warranty, 50,000 hours

LIGHTING CONFIGURATIONS

Direct

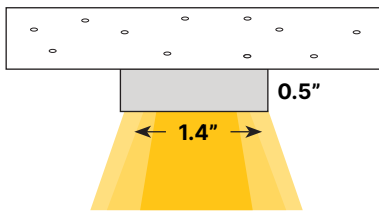

Designed & Built in
BOSTON

Project Name _____ Fixture Type _____

1) FIXTURE DESIGN

PRODUCT	FIXTURE LENGTH	FINISH	DAISY CHAIN
ESM140 1.4" Low-Profile Linear LED Flat Rail	1 - 1 ft 2 - 2 ft 3 - 3 ft 4 - 4 ft 6 - 6 ft 8 - 8 ft X_ - Specify Ft', In" (Ask Factory)	Powder Coated PMW - Matte White PMB - Matte Black PMG - Matte Gray PRAL_ - Specify RAL # Anodized ACL - Clear Anodized ACU_ - Custom Anodized #	NDC - No: Daisy Chain YDC - Yes: Daisy Chain

2) LED LIGHT ENGINE

CRI	CCT	OPTIC (DIRECT ONLY)	DIRECT BEAM PATTERN	DIRECT OUTPUT
80 - Std. 80 CRI 90 - Std. 90 CRI 95 - High-Def. 95 CRI SUN - Full SunLike	27 - 2700K 30 - 3000K 35 - 3500K 40 - 4000K XD - Dim-to-Warm XT - Tunable X_ - Specify CCT Specify Dim-to-Warm and Tunable between 2700K-6500K.	OFT - Flat Lens OLG - Light Guide ORMCOW - Round MCO, White ORMCOB - Round MCO, Black ORMCOG - Round MCO, Graphite	DLAM - Lambertian DBW60 - Batwing 60° DM50 - Medium 50° DN40 - Narrow 40° D4015 - Asym 40° at 15° Tilt X_ - Specify Beam ¹ DLAM - Lambertian DBW60 - Batwing 60° DA4560 - Asym 45° at 60° Tilt DS25 - Micro Cavity Optics Spot 25°	35 - 350 lm/ft 50 - 500 lm/ft 75 - 750 lm/ft 100 - 1,000 lm/ft X_ - Specify lm/ft

3) FIXTURE POWER & CONTROLS

LINE VOLTAGE (DC)	REMOTE DRIVER (POWER) ³	
UNV - 120/277V 347 - 347V	FDND - Factory Non-Dimming FD00 - Factory 0-10V 0.1% Dim FD01 - Factory 0-10V 1% Dim FD10 - Factory 0-10V 10% Dim FDDA - Factory DALI 0.1% Dim FDDX - Factory DMX Dim FDTR - Factory TRIAC Dim LD01 - Lutron Hi-Lume 1% Dim X_ - Specify Driver	Footnotes: ¹ Contact factory about custom beam options. ² Standard driver box is included

4) FIXTURE MOUNTING & CONNECTIONS

MOUNTING TYPE	POWER CORD	CONNECTOR
SMC - Surface Mount Clip SMM - Surface Mount Magnet TC1 - 9/16" Flat T-Bar Mount TC2 - 9/16" Bolt Slot T-Bar Mount TC3 - 15/16" Flat T-Bar Mount TC1, TC2 and TC3 clips directly to grid t-bar.	P24W - 24" White Cable Kit P24B - 24" Black Cable Kit	SW - Strip Wire FP - Factory Plug

OPTIONAL	
EMERGENCY BACKUP	WIRELESS MODULE
<p>EMC - Emergency Circuit EMB - Emergency Battery (10 W — Remote) X_ - Specify Backup</p> <p>Specify requirements at time of order.</p>	<p>WCN - Wireless Communication Node (Connected to LED Driver In-Fixture or In-Driver Box) PIR - Wireless Communication Node + PIR Sensor (Standard Lens for Low Bay < 10') MW - Wireless Communication Node + MW Sensor (Standard for Low Bay < 10') X_ - Other – Specify Embedded Component or Specific Non-Standard Sensor Detection Range</p>

DIMENSIONS & INSTALLATION

Dimensions

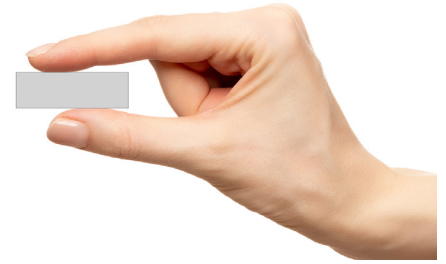
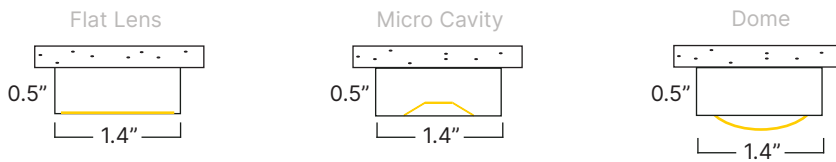

Standard Fixtures

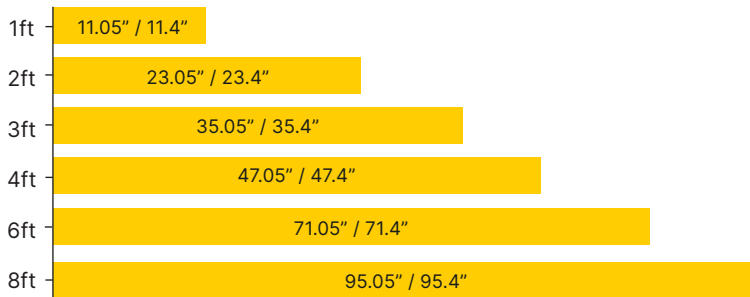

Lens Length / Fixture Length

Mounting Type

T-Bar Mount

Installs into a ceiling grid system and mount on to, or replace, typical T-Bar elements. Available with a range of accessories, mounts and inserts that provide easy customization of visual appearance and performance enhancements.

Surface Mount

Installs onto a surface. Available with a range of accessories, mounts and inserts that provide easy customization of visual appearance and performance enhancements.

Wall Mount

Installs onto a wall. Available with a range of accessories, mounts and inserts that provide easy customization of visual appearance and performance enhancements.

Mounting Options

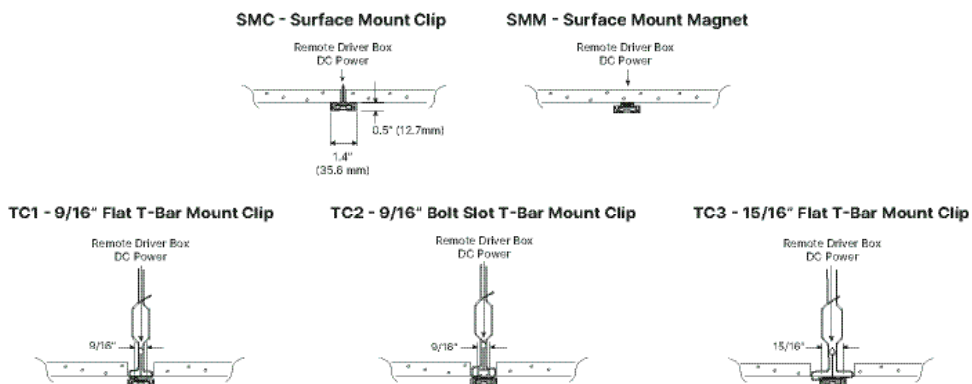

SMARTBEAM® TECHNOLOGY

The Ultimate Control of Lighting Distributions

SmartBeam makes it easy to specify the exact light required for any architectural space. Available in every XICO product; it is now possible to create truly tailored and engaging lighting that transform spaces, improves visual comfort, and saves energy.

To learn more about our SmartBeam Technology, please click or scan the QR Code.



Direct Optics Choices

DIRECT OPTICS	BEAM PATTERN						
	DLAM	DBW60	DA4560	DA4015	DM50	DN40	DS25
Flat Lens	■	■		■	■	■	
Light Guide	■	■	■				
MCO							■

LPW Efficacy Conversion Chart

CODE	CCT SELECTED							
	2200K	2700K	3000K	3500K	4000K	5000K	5700K	6500K
80	–	0.91	0.96	1.00	1.04	1.11	1.11	1.11
90	–	0.91	0.96	1.00	1.04	1.11	1.11	1.11
95	–	0.91	0.96	1.00	1.04	1.11	1.03	1.04
SUN	–	0.90	0.92	1.00	1.01	1.07	1.04	1.05

LPW Performance

	DIRECT						
	DLAM	DBW60	DA4560	DA4015	DM50	DN40	DS25
LM/W	130	149	149	149	149	135	82

DIRECT PHOTOMETRICS

48" Length, 80+/3500K CRI/CCT, 3,000 Lumens

Static White Light

DLAM: Lambertian

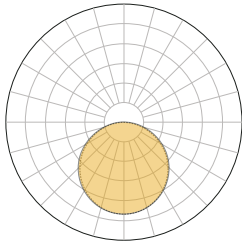

LM/FT	W/FT	LM/W
350	2.6	134.6
500	3.7	135.1
750	5.6	133
1000	7.5	133.3

DBW60: Batwing 60°

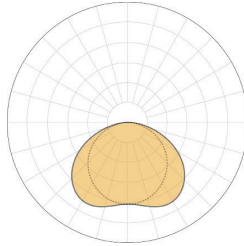

LM/FT	W/FT	LM/W
350	2.5	140
500	3.5	142.9
750	5.3	141
1000	7.1	140.1

DA4560: Asymmetric 55° at 60° Tilt

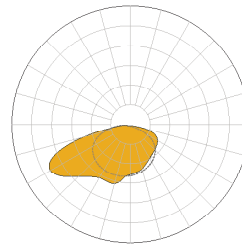

LM/FT	W/FT	LM/W
350	2.8	125
500	4.1	122
750	6.1	123
1000	8.1	123.5

DA4015: Asymmetric 40° at 15° Tilt

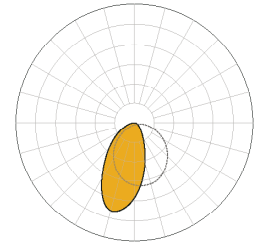

LM/FT	W/FT	LM/W
350	2.7	129.6
500	3.8	131.6
750	5.7	131
1000	7.6	131.6

DM50: Medium 50°

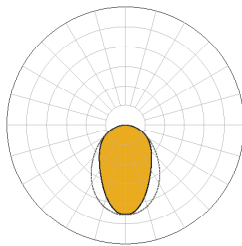

LM/FT	W/FT	LM/W
350	2.8	125
500	3.9	128.2
750	5.8	130
1000	7.7	129.9

DN40: Narrow 40°

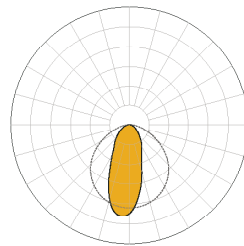

LM/FT	W/FT	LM/W
350	2.3	152
500	3.3	151.5
750	5	149
1000	6.7	149.3

DS25: Micro Cavity Optic Spot 25°

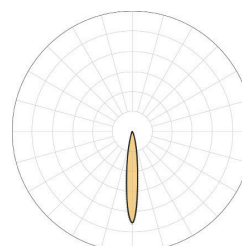



LM/FT	W/FT	LM/W
350	2.3	152
500	3.3	151.5
750	5	151
1000	6.7	149.3

COMPATIBLE OPTIC

FLAT LENS	LIGHT GUIDE	MCO

OPTICS CONFIGURATIONS

		
Flat Lens	Light Guide	Round MCO
White Flat Lens OFT	White Light Guide OLG	White Round MCO ORMCOW
		Black Round MCO ORMCOB
		Graphite Round MCO ORMCOG

POWER & CONTROLS

Voltage

Fixture Voltage (AC)

120–277 VAC
347 VAC, 50/60 Hz

Power Location

Remote

LED Driver

Factory Selected, 36–39V Constant Current

Drivers

FDND - Factory Non-Dimming
FD00 - Factory 0-10V 0.1% Dim
FD01 - Factory 0-10V 1% Dim
FD10 - Factory 0-10V 10% Dim
FDDA - Factory DALI 0.1% Dim
FDDX - Factory DMX Dim
FDTR - Factory TRIAC Dim
LD01 - Lutron Hi-Lume 1% Dim
X_ - Specify Driver

Emergency Backup (Optional)

EMC - Emergency Circuit
EMB - Emergency Battery
 (10 W — Remote)
X_ - Specify Backup

Power

10 W

Illumination Time

90 minutes

IP Rating

Suitable for Dry and Damp Locations,
indoor use only

XBox

Remote Driver Boxes (Optional)

To create a clean and organized power solution for multiple fixture installations see our XBox Specification Guide. Reach out to a XICO Sales Representative to discuss your projects needs.

Compatible Control Options



