

TBar & Ceiling Grid Mounting

What to Know

Risk of fire and electrical shock. Installation requires knowledge of electrical systems and should be installed by a qualified electrician. If not qualified, **DO NOT ATTEMPT INSTALLATION.**

- 1 Once the grid structure has been installed, engage the fixture into the desired location. Insert one end of the fixture at an angle and then the opposite end.

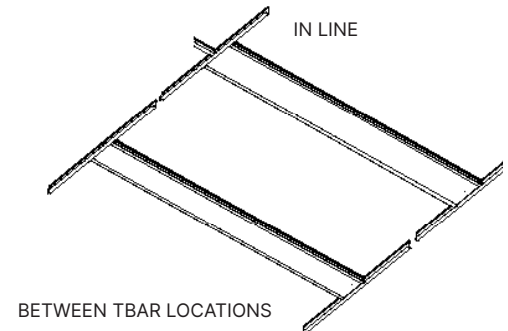
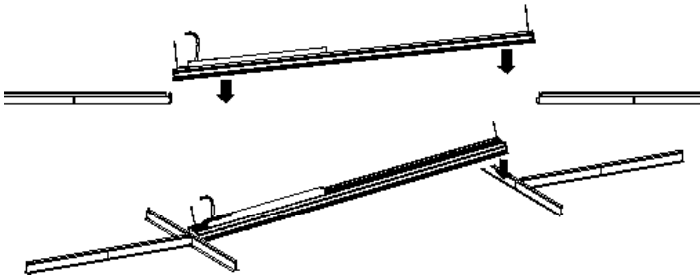

- 2 The fixture can be installed in line, replacing a Tbar or freely between Tbar locations. When installing in line, you may be required to fold over the Tbar fin, to allow clearance for the end cap.

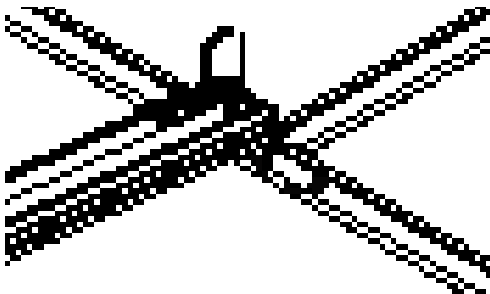

- 3 If required, Tbar fins are included and can be installed anywhere along the fixture body to received a Tbar that runs perpendicular to the fixture.

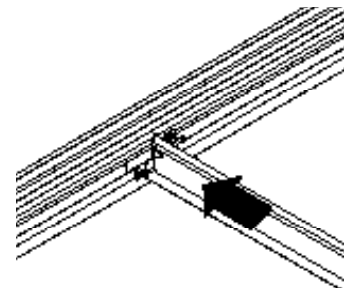

- 4 An enclosed driver box is provided which is either fastened to the top of the fixture housing or installed remotely. Connect the fixture's Driver Box wires to the power source. Add structural supports as needed. Refer to the wiring diagram.

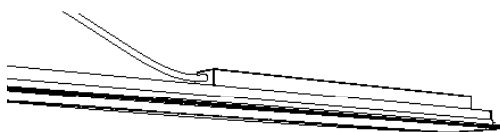

Care Instructions:

Wipe with a soft cloth only. Always avoid using harsh chemicals and/or cleaners.

Continuous Run

- 1 Place the 2 Fixtures on a flat and clean surface with the open ends facing each other. The joiner bracket will be pre-installed in one of the fixtures.



- 2 You may be required to loosen a screw to free up the joiner bracket.

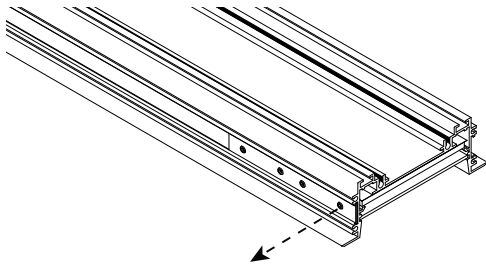

- 3 Center the bracket between the 2 fixtures. Secure one side of the joiner to the fixture housing.

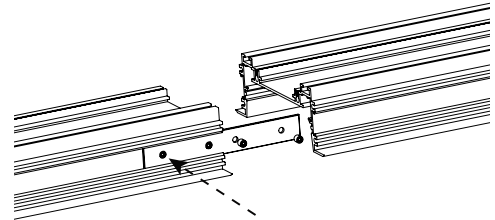

- 4 Pull the fixtures together and tighten the remaining screws. Repeat steps for the other side of the fixture.

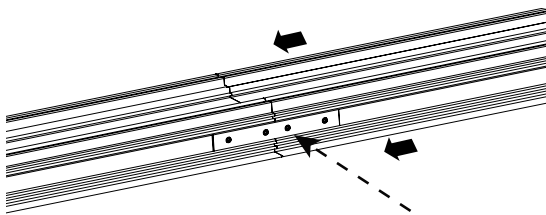

Care Instructions:

Wipe with a soft cloth only. Always avoid using harsh chemicals and/or cleaners.

Wiring Diagram

AC Power
0-10V Dimming

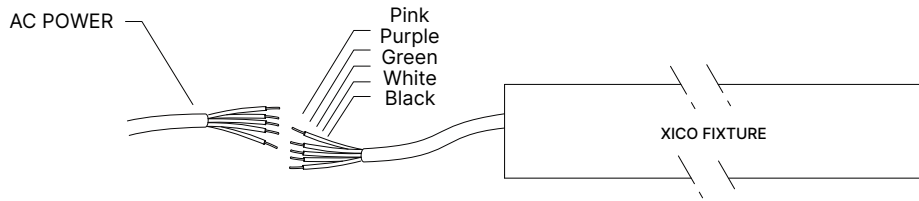
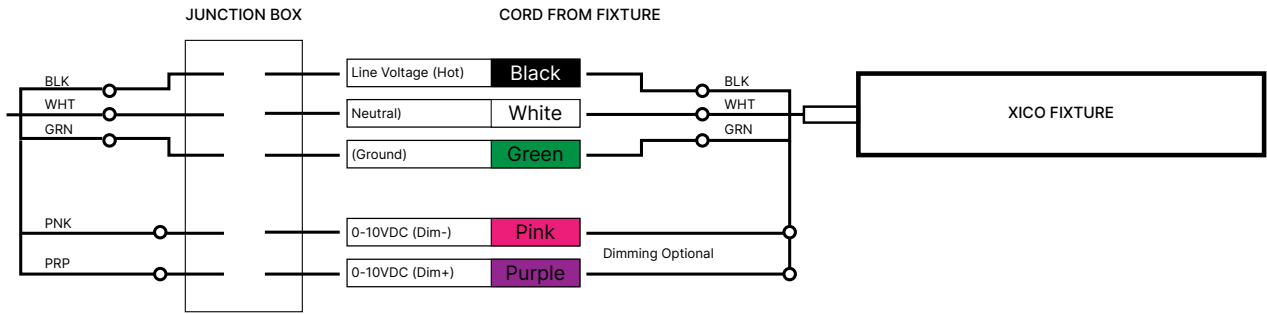

Recessed Drywall Mounting

What to Know

Risk of fire and electrical shock. Installation requires knowledge of electrical systems and should be installed by a qualified electrician. If not qualified, **DO NOT ATTEMPT INSTALLATION.**

- 1 Connect power to the fixture. An enclosed driver box is provided which is fastened to the top of the fixture housing or loose for remote installation. Check to make sure you have a secure connection and that the fixture is wired correctly before moving to the next step. Refer to the wiring diagram.

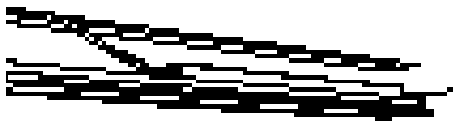

- 2 Turn up the Mounting Springs and fit the fixture through the drywall cutout, working your way down the fixture at each spring location.

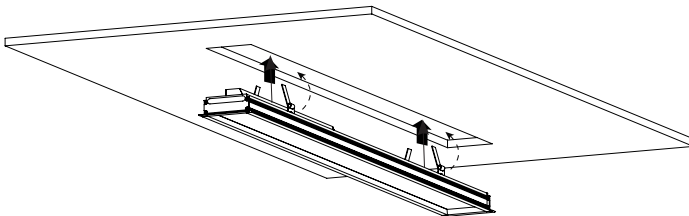

- 3 The springs will pull the fixture up to the mounting surface and complete the fixture installation.

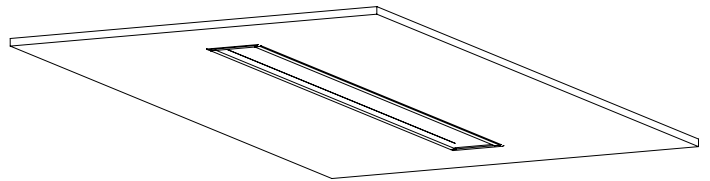

- 4 The springs push against the top of the drywall surface and hold the fixture in place.

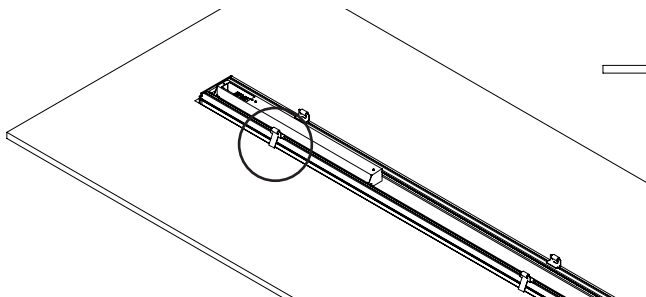

Care Instructions:

Wipe with a soft cloth only. Always avoid using harsh chemicals and/or cleaners.

Continuous Run

- 1 Place the 2 Fixtures on a flat and clean surface with the open ends facing each other. The joiner bracket will be pre-installed in one of the fixtures.



- 2 You may be required to loosen a screw to free up the joiner bracket.

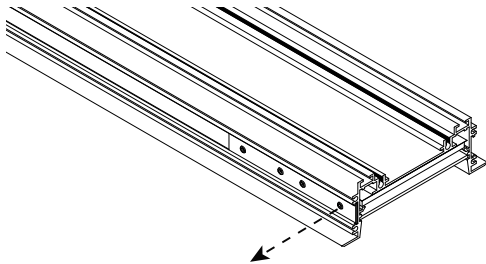

- 3 Center the bracket between the 2 fixtures. Secure one side of the joiner to the fixture housing.

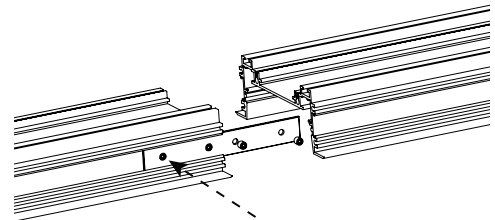

- 4 Pull the fixtures together and tighten the remaining screws. Repeat steps for the other side of the fixture.

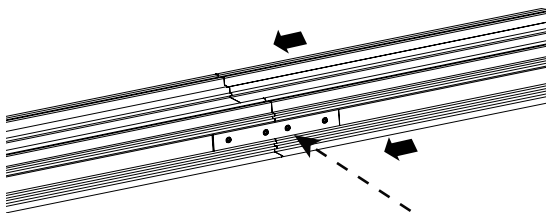

Care Instructions:

Wipe with a soft cloth only. Always avoid using harsh chemicals and/or cleaners.

Wiring Diagram

AC Power
0-10V Dimming

